

## Termisk Flödesvakt Serie SP & Paddelflödesvakt Serie SF

[www.processcenter.se](http://www.processcenter.se)

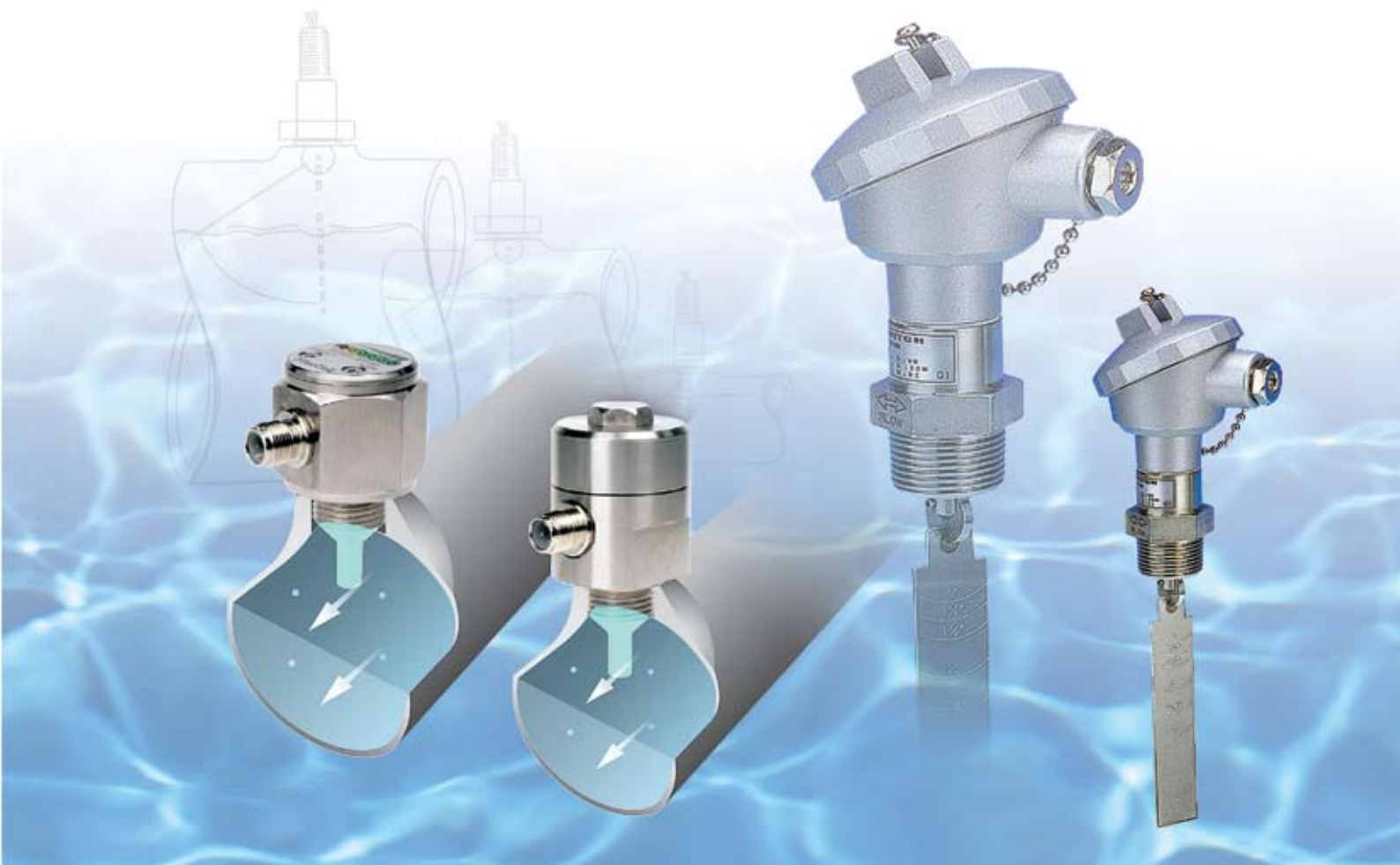

### Applikationer:

- Vatten (varmvatten, kylvatten, saltvatten, avsaltat vatten)
- Diesel och eldningsolja
- Alla typer av kemikalier och oljor
- Luftkonditionering
- Livsmedel
- Vattenverk och reningsverk
- Energiverk
- Hydrauliska applikationer
- Läckageövervakning



# Termisk Flödesvakt Serie SP & Paddelflödesvakt Serie SF

www.processcenter.se

## PRODUCT SPECIFICATIONS

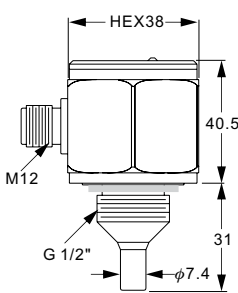
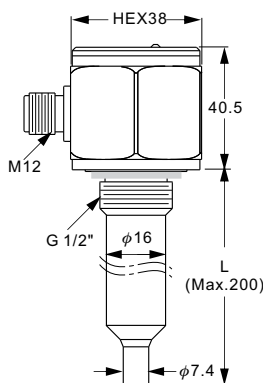
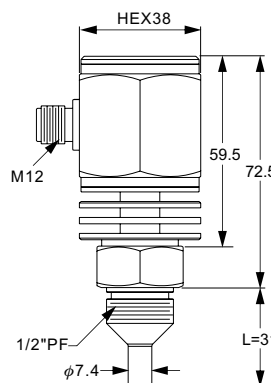
Drawings			
<b>Model</b>	<b>SP200</b> -□-□-□-□-□ <b>Compact model</b>	<b>SP201</b> -□-□-□-□-□ <b>Extension model</b>	<b>SP202</b> -□-□-□-□-□ <b>High Temp. model</b>
<b>Measuring range</b>	Water: 1~150 cm/s Oil: 3~300 cm/s	Water: 1~150 cm/s Oil: 3~300 cm/s	Water: 1~150 cm/s Oil: 3~300 cm/s
<b>Ambient temp.</b>	-20 ~ 80°C	-20 ~ 80°C	-20 ~ 80°C
<b>Operating temp.</b>	-20 ~ 80°C	-20 ~ 80°C	-20 ~ 120°C
<b>Alarm output</b>	Open Collector : NPN / PNP (<400mA) Relay : 1A/30Vdc, 0.3A/125Vac (NO or NC)		
<b>Operating pressure</b>	100 bar (max.)	100 bar (max.)	100 bar (max.)
<b>Led indication</b>	Flow velocity below set point- Red LED on, Open Flow velocity equals set point- Yellow LED on, Close Flow velocity above set point- 4 Green LED to indicate flow speed, Close		
<b>Housing</b>	SUS304 / 316 / 316L		
<b>Wetted part</b>	SUS304 / 316 / 316L		
<b>Protection level</b>	IP67		
<b>Warm-up time</b>	Approx. 10 Sec	Approx. 15 Sec	Approx. 15 Sec
<b>Connection thread</b>	G1/2, G1/4, NPT1/2	G1/2, NPT1/2	G1/2, G1/4, NPT1/2
<b>Operating voltage</b>	19 ~ 30Vdc		
<b>Power consumption</b>	50mA (max.)		
<b>Wiring</b>	3-wire NPN/PNP Power-brown Grounding-blue Output-black		
<b>Accessory</b>	Gasket, 2m Cable		

# Termisk Flödesvakt Serie SP & Paddelflödesvakt Serie SF

www.processcenter.se

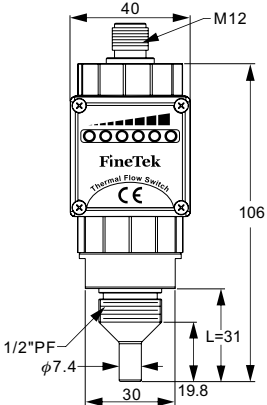

## PRODUCT SPECIFICATIONS

<b>Drawings</b>	
<b>Model</b>	<b>SP220-□-□-□-□ Economy model</b>
<b>Measuring range</b>	Water: 1~150 cm/s Oil: 3~300 cm/s
<b>Ambient temp.</b>	-20 ~ 80°C
<b>Operating temp.</b>	-20 ~ 80°C
<b>Alarm output</b>	Open Collector : NPN / PNP (<400mA) Relay : 1A/30Vdc, 0.3A/125Vac (NO or NC)
<b>Operating pressure</b>	100 bar (max.)
<b>Led indication</b>	Flow velocity below set point- Red LED on, Open Flow velocity equals set point- Yellow LED on, Close Flow velocity above set point- 4 Green LED to indicate flow speed, Close
<b>Housing</b>	PC
<b>Wetted part</b>	SUS304 / 316 / 316L
<b>Protection level</b>	IP65
<b>Warm-up time</b>	Approx. 15 Sec
<b>Connection thread</b>	G1/2, NPT1/2
<b>Operating voltage</b>	19 ~ 30Vdc
<b>Power consumption</b>	50mA (max.)
<b>Wiring</b>	3-wire NPN/PNP Power-brown Grounding-blue Output-black
<b>Accessory</b>	Gasket, 2m Cable
<b>Footnote</b>	Sensitivity and Alarm setting not available.

# Termisk Flödesvakt Serie SP & Paddelflödesvakt Serie SF

www.processcenter.se

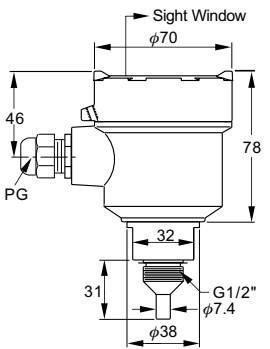
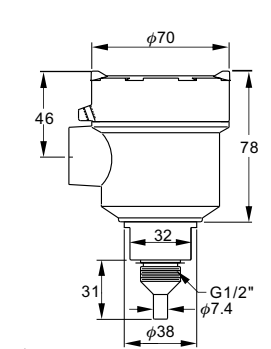
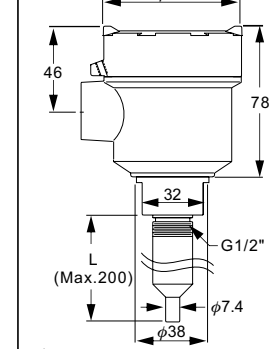
## PRODUCT SPECIFICATION

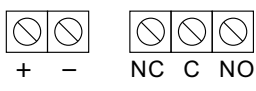
Drawings			
		 Cert. Number GYJ12.1521x	 Cert. Number GYJ12.1521x
	<b>Model</b>	<b>SP210 Stainless Steel model</b>	<b>SP170-(1/2) Explosion Proof model</b>
<b>Measuring range</b>	Water: 1~150 cm/s Oil: 3~300 cm/s		
<b>Ambient temp.</b>	-20 ~ 80°C		
<b>Operating temp.</b>	-20 ~ 80°C		
<b>Alarm output</b>	Relay: 5A/250Vac	Relay: 3A/250Vac	
<b>Operating pressure</b>	100 bar (max.)		
<b>Led indication</b>	Flow velocity below set point- Red LED on, Open Flow velocity equals set point- Yellow LED on, Close Flow velocity above set point- 4 Green LED to indicate flow speed, Close		
<b>Housing</b>	SUS304		
<b>Wetted part</b>	SUS304 / 316 / 316L		
<b>Protection level</b>	IP67		
<b>Warm-up time</b>	Approx. 15 Sec		
<b>Connection thread</b>	G1/2, NPT1/2		
<b>Operating voltage</b>	19 ~ 30Vdc		
<b>Power consumption</b>	60mA (max.)		
<b>Wiring</b>	5-wire Relay Output Power- red Grounding- black COM- white NC- yellow NO- blue		
<b>Accessory</b>	Gasket, 2m Cable	_____	_____

# Termisk Flödesvakt Serie SP & Paddelflödesvakt Serie SF

www.processcenter.se

## INSTALLATION

### INSTALLATION

1. Use the water-proof gasket provided
2. The distance "a" should be 4 times larger than the switches' screw diameter. (Fig. 1)
3. The pipe is bubble free for proper functioning. (Fig. 2)
4. For not-completely-filled pipes, install from the bottom. The liquid level needs to be higher than the probe height. (Fig. 3)
4. Screw tightly to avoid. Can be installed from various angles. For best sensitivity and response speed, please install using in the demonstrated in Fig. 4
5. Installing a filter upstream can decrease liquid impurities which can reduce wear and tear on the switch.

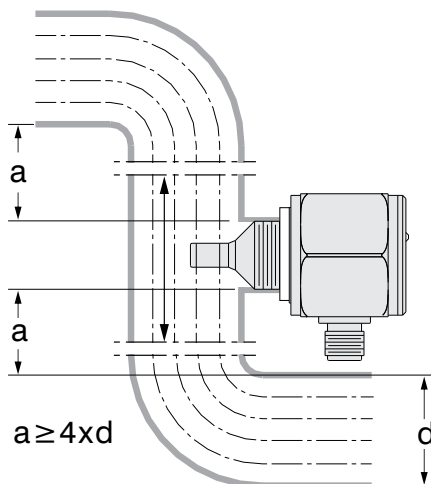

Fig. 1

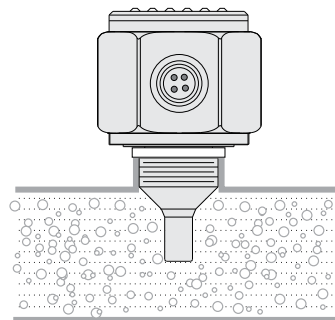

Fig. 2

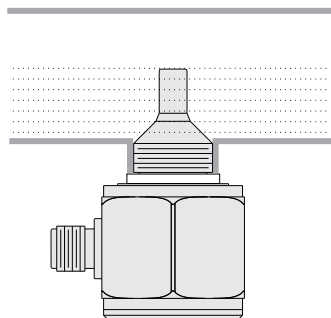

Fig. 3

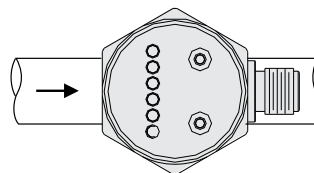

Fig. 4

# Termisk Flödesvakt Serie SP & Paddelflödesvakt Serie SF

www.processcenter.se

## CWIRING AND CONNECTIONS

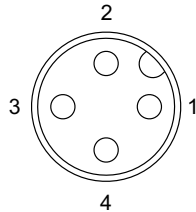

Fig. 5  
Wire terminal diagram  
(NPN, PNP and 1A relay output type)

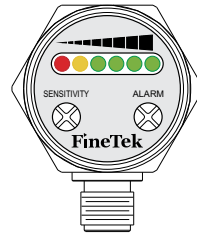

Fig. 6

## WIRING

3-wire

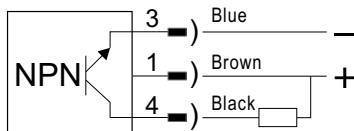

Fig. 7, NPN output type wiring

4-wire

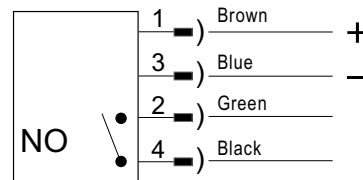

Fig. 10, Relay output type wiring (NO)

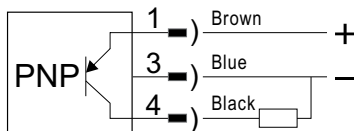

Fig. 8, PNP output type wiring

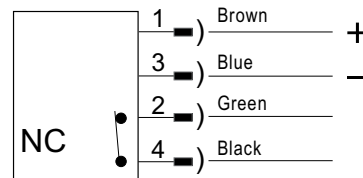

Fig. 11, Relay output type wiring (NC)

5-wire

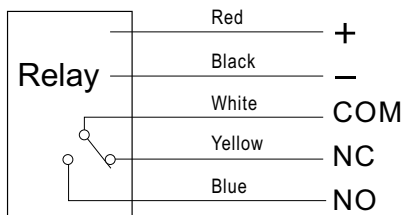
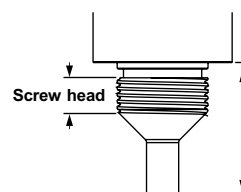

Fig. 9, Relay output type wiring

## SCREW TABLE

Screw	Standard			
	PF,BSP		PT,NPT	
	Screw head	L	Screw head	L
1/4"	8.5mm	25mm	10mm	25mm
1/2"	10.5mm	31mm	19mm	40mm
1"	16mm	36mm	20mm	40mm

Screw	Extension			
	PF,BSP		PT,NPT	
	Screw head	Screw head	Screw head	Screw head
1/2"	11.5mm	16mm	16mm	20mm
1"	16mm		20mm	





# Termisk Flödesvakt Serie SP & Paddelflödesvakt Serie SF

www.processcenter.se

## HOW TO ORDER

SP2   -  -   -  -  - (     )

### Model Description

- 0: Compact model
- 1: Stainless Steel model  $\phi 70 \times 78$   
(for SPDT 5A/250Vac)
- 2: Economy model (Plastic Housing)

### Probe Type

- 0: Standard model
- 1: Probe Extension model
- 2: 120°C High Temperature model  
(Except SP220)

### Material

- 0: SUS304    L: SUS316L    S: Other
- 6: SUS316

### Connection

Size	Specification
A: 3/8" (10A)	Q: PT
B: 1/2" (15A)	T: BSP
C: 3/4" (20A)	R: PF
D: 1" (25A)	U: NPT
2: 1/4"	V: GAS
S: Other	S: Other

\*Standard connection: 1/2"PF, 1/2"NPT, 1/2"PT

### Output

- N: NPN (current limit: 400mA)
- P: PNP (current limit: 400mA)
- A: Relay 1A/30Vdc (NO)
- B: Relay 1A/30Vdc (NC)
- C: Relay 5A/250Vac (SPDT) (for SP210/ SP211/ SP212)

### Cable Wire Length(unit: m)

- 2: 2m    5: 5m

### Length L (Unit: mm)

- ※ Length tolerance:  $\pm 5$ mm
- ※ Dimensions are subject to change
- ※ Customized lengths available on request \* Max.200mm

Process Center AB  
 Skogsbrynsvägen 8 C  
 236 31 Höllviken  
 040 452900 info@processcenter.se



# Termisk Flödesvakt Serie SP & Paddelflödesvakt Serie SF

www.processcenter.se

## PADDLE TYPE FLOW SWITCH

### PRINCIPLE

Flow Switch can detect liquid movement in pipes.  
 When the liquid is static or nonexistent, the spring is fully extended pulling the magnet downward and opening the switch.  
 As flow occurs and the paddle is thrust forward 20°C~30°C (or more) the paddle will push the magnet upward and actuate the switch (closing the circuit)  
 The length of paddle can be adjusted to the pipe's diameter.

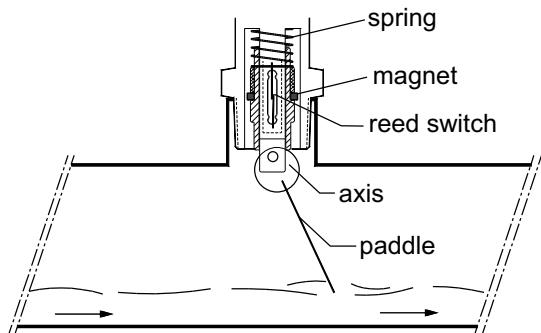

Switch on in case of liquid flowing in pipes

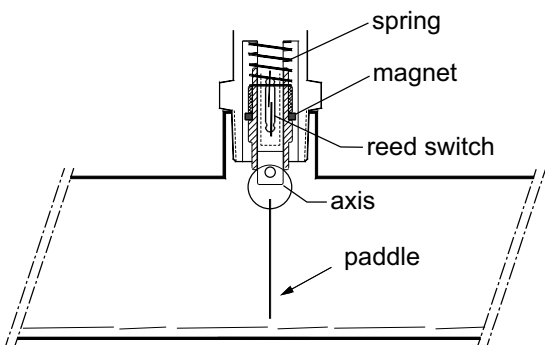

Switch off in case of no moving liquid in pipes

### SECTIONAL DRAWINGS

1. O-Ring
2. Paddle
3. Axis
4. Reed switch
5. Spring
6. Magnet
7. Housing
8. Screw
9. Center rod

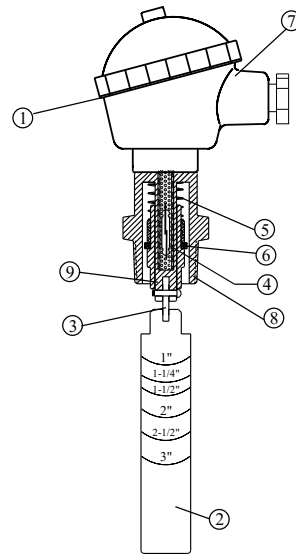

NEPSI 

MODEL: SF1710

Explosion proof model

MODEL: SF1800

Standard model

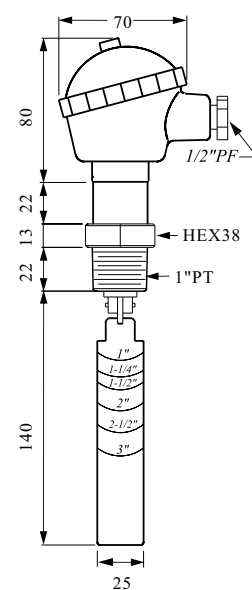
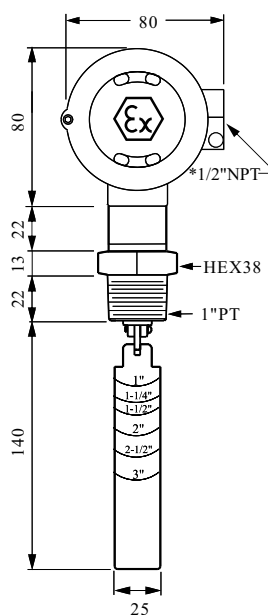

# Termisk Flödesvakt Serie SP & Paddelflödesvakt Serie SF

www.processcenter.se

Spec.	Model	SF1710	SF1800
Housing material		Aluminum Alloy, Ex d IIC T6~T4	Aluminum Alloy, IP65
Operation temp.		-30°C~100°C	-30°C~150°C
Wetted material		SUS304	SUS304
Operation pressure		Max. 355 PSIG	Max. 355 PSIG
Pressure drop allowance		3 PSIG	3 PSIG
Set point tolerance		± 25%	± 25%
Repeatability tolerance		± 5%	± 5%
Contact capacity		60W 220Vac/200Vdc, SPDT	60W 220Vac/200Vdc, SPDT

## FLOW CONTROL RANGE TABLE

Paddle Length	1"		1-1/2"		2"		2-1/2"		3"	
	Act.	De-Act.	Act.	De-Act.	Act.	De-Act.	Act.	De-Act.	Act.	De-Act.
1"	4.7	3.9	10.9	8.3	19.9	16.1				
1-1/4"			7.7	6.1	16.5	12.3	31.3	22.8		
1-1/2"			5.7	4.5	13.4	9.5	25.2	18.5		
2"					8.4	6.3	15.1	12.8	29.7	21.9
2-1/2"							13.9	10	20.4	15.4
3"									17.1	12.8

※ 1 Gallon=3.7854 Litter

## INSTALLATION

1. The paddle length is dependent on the lowest paddle point to actuate the switch. Cut the paddle at appropriate pipe size mark or wherever desired. The minimum is 1".
2. The paddle must be at a right angle to the direction of flow
3. The FLOW mark on the screw must be parallel to the pipe.
4. Before installing the unit to a tee pipe, apply thread seal tape to the screw and then tighten.

- Not recommended for 1" or smaller NPT plastic pipes.

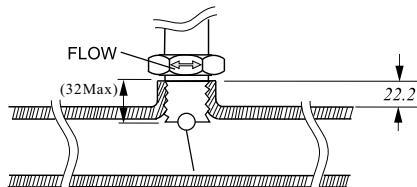

## CAUTION

1. The pressure and temperature ranges as shown in the catalog, must not be exceeded and also take the abrupt pressure and temperature into considerations.
2. Large sudden changes in liquid temperature and density (specific gravity) changes will influence the flow switch accuracy
3. Although highly rigid and durable, shock and vibration should be minimized.
4. Excessive fluid debris might inhibit paddle operation. Occasionally remove switch and clean off any debris.
5. Sealing electrical connections and the connection will reduce moisture damage.