



Process Center AB

**Manual Läckagelarm / Vätskelarm RS-3000**

[www.processcenter.se](http://www.processcenter.se)

**Manual**  
**Läckagelarm / Vätskelarm**  
**För**  
**Sensorer RS-3000FA/FAP**  
**Förstärkarrelä RS-3000C**

Process Center AB

Process Center AB  
Skogsbrynsvägen 8c  
236 31 Höllviken

040 452900 [info@processcenter.se](mailto:info@processcenter.se)



# Manual Läckagelarm / Vätskelarm RS-3000

## Introduction

We appreciate that you have purchased our Liquid Leakage Sensor.

Before you install or operate it, please read this operation manual thoroughly, and follow the instruction in order to avoid any accidents, malfunction, defects and hazards.

Please keep this manual with good care as long as the sensor is being operated.

## Table of Contents

<b>1. Designation of Sensors</b> .....	3
1-1. Detection Unit RS-3000FA/RS-3000FAP .....	3
1-2. Control Unit RS-3000C .....	3
<b>2. Installation</b> .....	4
2-1. Detection Unit RS-3000FA .....	4
2-2. Detection Unit RS-3000FAP .....	4
2-3. Control Unit RS-3000C .....	6
<b>3. Wiring Instruction</b> .....	7
3-1. Detection Unit Without Control Unit .....	7
3-2. Control Unit RS-3000C and Detection Unit .....	8
<b>4. Operation</b> .....	9
4-1. Detection Unit without Control Unit .....	9
4-2. Control Unit RS-3000C and Detection Unit .....	9
4-3. Distinction of abnormal status .....	10
<b>5. Reset Procedure after Alarm Clearance</b> .....	11
<b>6. Specification</b> .....	12
6-1. Detection Unit .....	12
6-2. Control Unit .....	12

Process Center AB



# Manual Läckelarm / Vätskelarm RS-3000

## 1. Designation of Sensors

### 1-1. Detection Unit: RS-3000FA, RS-3000FAP

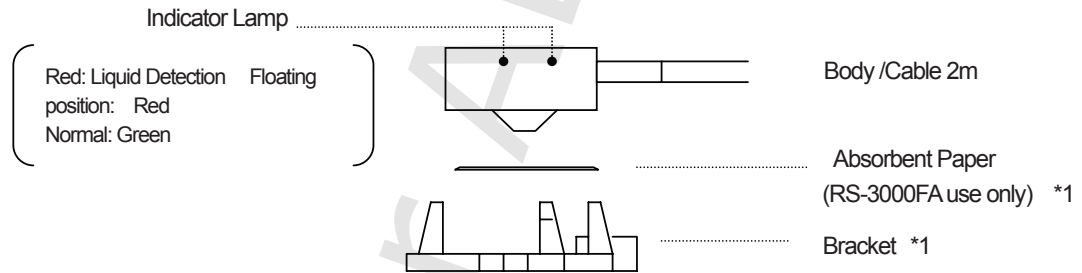

\*1: The Bracket is different for RS-3000FA and for RS-3000FAP. These differences are adsorbent paper use or not. For details, refer page 12 Specifications.

### 1-2. Control Unit: RS-3000C

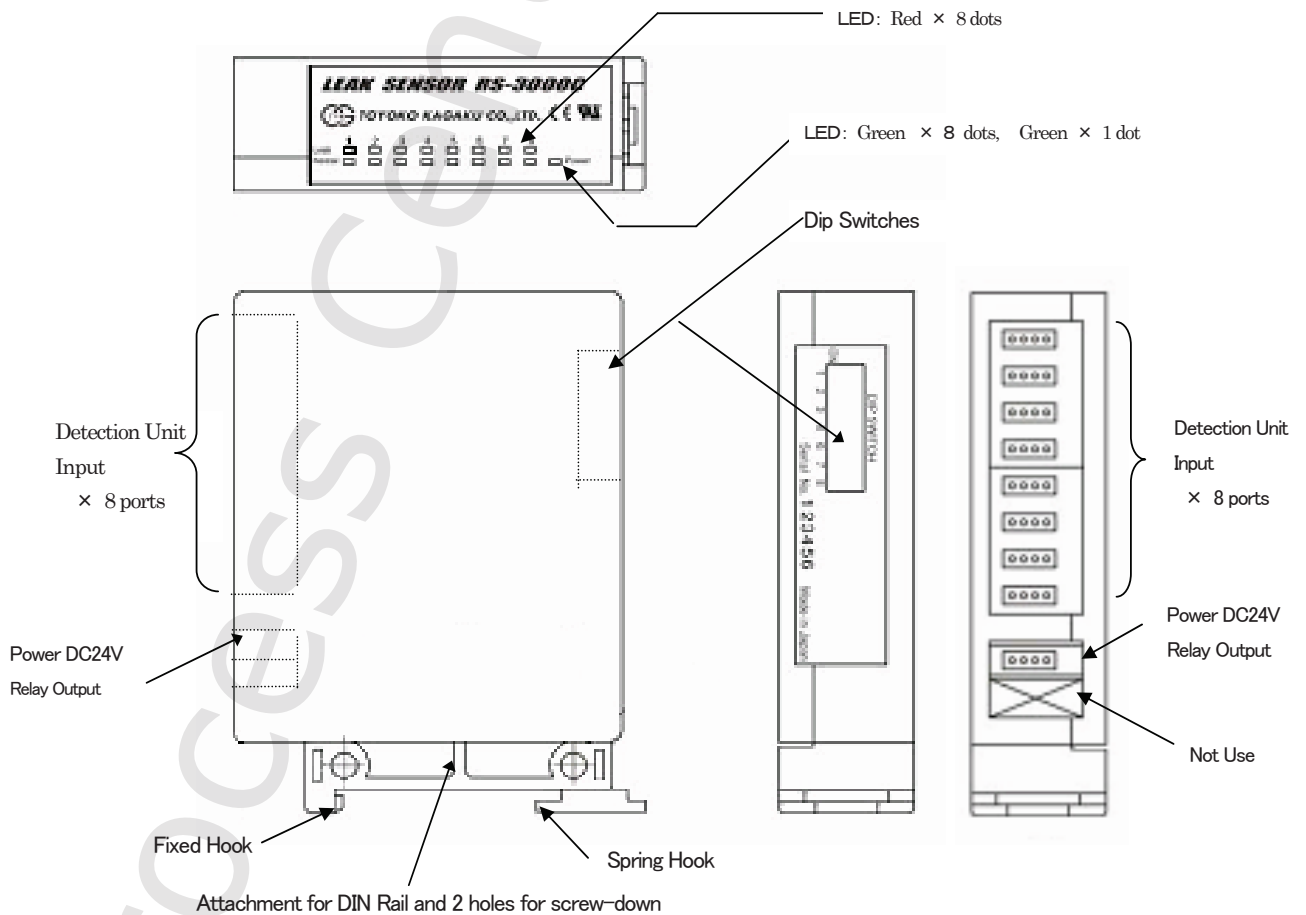



## Manual Läckagelarm / Vätskelarm RS-3000

### 2. Installation

#### 2-1. Detection Unit: RS-3000FA

(1) Place the Bracket of the Detection Unit on the surface where you want to detect the leakage, and fix it firmly.

\* Use the correct Bracket for the detection Unit. Refer to page 8 [Bracket Specification].

(2) Place a piece of the Absorbent paper onto the Bracket.

**NOTE:** *Be aware not to use 2 or more pieces of the Paper at a time in the Bracket.*

(3) To mount the Sensor Body, push it into the Bracket completely.

**NOTE:** *Verify that the Body has fixed entirely and it does not hook up at intermediate height in the Bracket.*

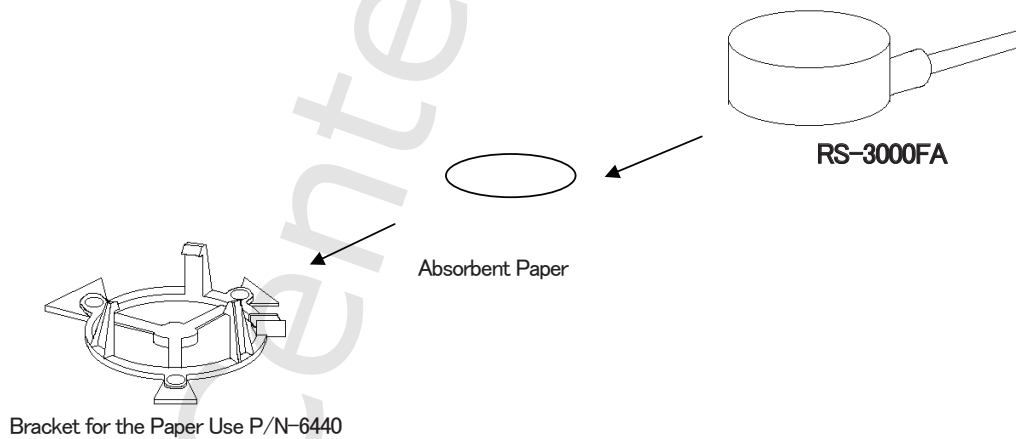

#### 2-2. Detection Unit: RS-3000FAP

(1) Place the Bracket of the Detection Unit on the surface where you want to detect the leakage, and fix it firmly.

\* Use the correct Bracket for the detection Unit. Refer to page 12 [Bracket Specification]

(2) To mount the Sensor Body, push it into the Bracket completely.

**NOTE:** *Verify that the Body has fixed entirely and it does not hook up at intermediate height in the Bracket.*

**NOTE:** *Do not use any absorbent paper for this model.*

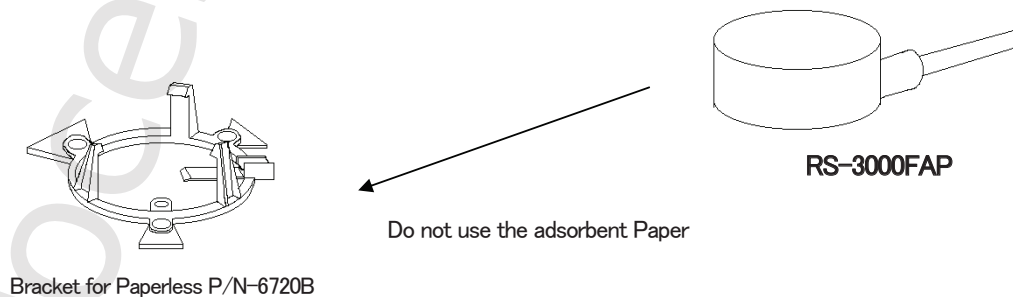



## Manual Läckagelarm / Vätskelarm RS-3000

www.processcenter.se

*NOTE: When the sensor is located at the position, align the direction of the detection unit against the Bracket as described below.*

*And make sure that the location of the sensor will not have any difficulties for maintenance job, or the direction of the cable heads for no obstructions where the cable may not be damaged by excessive bent or pressure.*

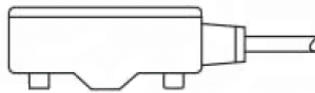
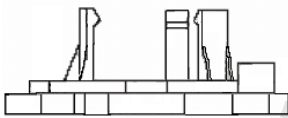
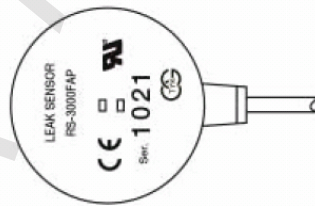
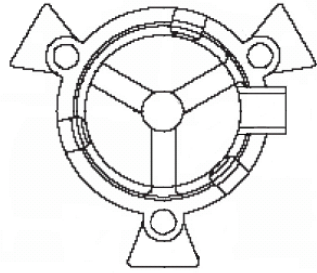

Bracket P/N-6440

Detection Unit RS-3000FAP

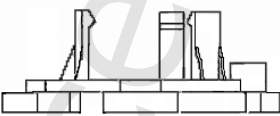
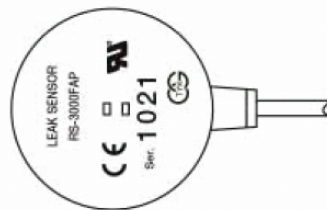
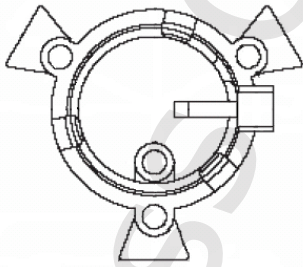

Bracket P/N-6720B

Detection Unit RS-3000FAP



## Manual Läckelarm / Vätskelarm RS-3000

www.processcenter.se

### 2-3. Control Unit RS-3000C

The RS-3000C Control Unit can install onto either DIN Rail or the surface of the plate.

(1) Install the unit onto the DIN Rail as below.

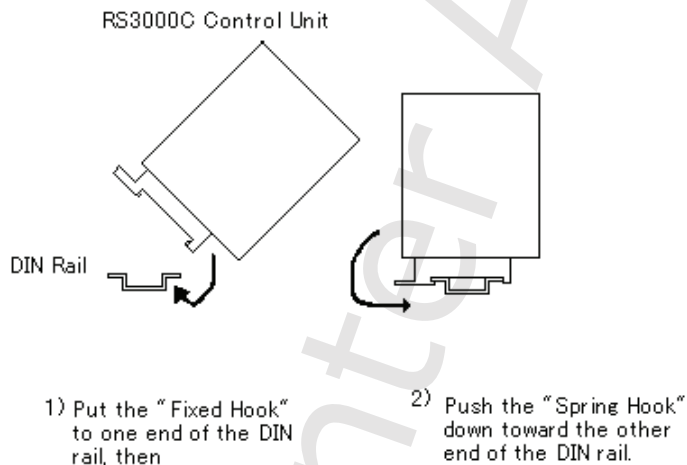

(2) When DIN Rail may not be applied, install the unit on the surface directly to be fixed using two of the screw as below.

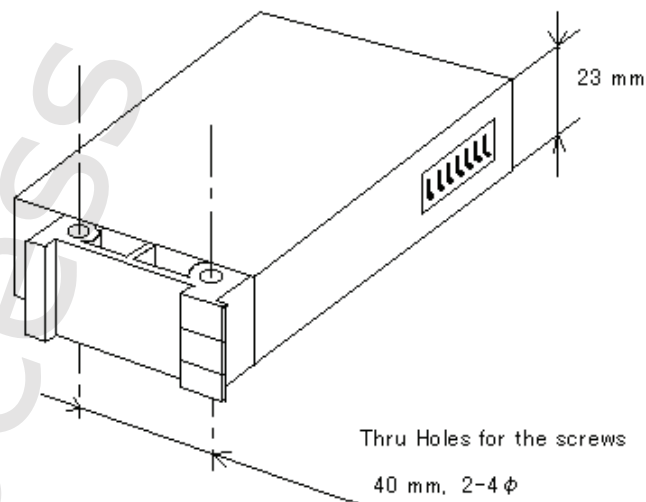



## Manual Läckelarm / Vätskelarm RS-3000

www.processcenter.se

### 3. Wiring Instruction

#### 3-1. Detection Unit without Control Unit

Both of RS-3000FA and RS-3000FAP is the same wiring feature.

- (1) The Detection Unit has a 3-wire sheath cable, 2 meters long.  
When the wire may be extended, do not exceed 30 meters long.  
Each wire will be connected as below.

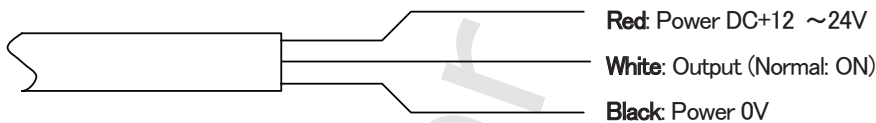

- (2) Connect the red wire (Positive pole) and the black wire (Negative pole) to the power source correctly. White wire is for an open collector output.

NOTE: Do not miswire with DC power source each other.

**NOTE: Use the sensor unit between the power voltages of DC12V to DC24V.**

- (3) The output capacity is limited up to 50mA maximum rating. Excessive rating may damage the output circuit.

**NOTE: When an inductive load may be applied, the protective treatment for the back electromotive is recommended. The following sample chart shows a hint to add a protective diode (F14C equivalent) to a relay coil load**

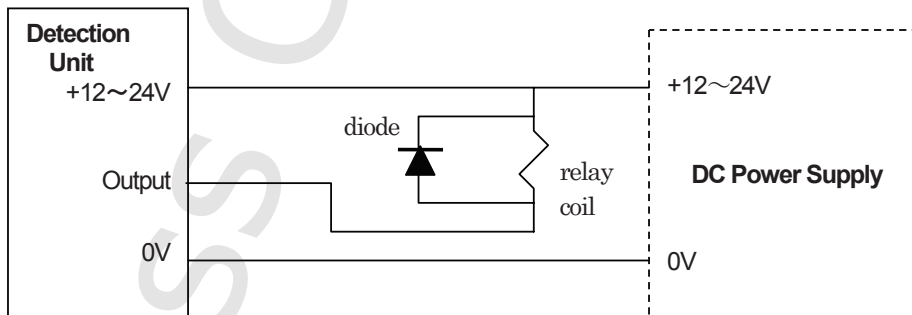

**NOTE: To avoid short circuit between each wire after the power is supplied, otherwise undesirable damage may occur.**



# Manual Läckelarm / Vätskelarm RS-3000

## 3-2. Control Unit RS-3000C and Detection Unit

Both of RS-3000FA and RS-3000FAP is the same wiring feature.

Buzzer Alarm Sensor RS-3000FA-BZ, RS-3000FAP-BZ, can be connected with RS-3000C as the same manner

Use the attached connectors for wiring with the Control Unit RS-3000C. The instruction of the connector is available by a separate sheet.

(1) Refer the wiring information in the below illustration.

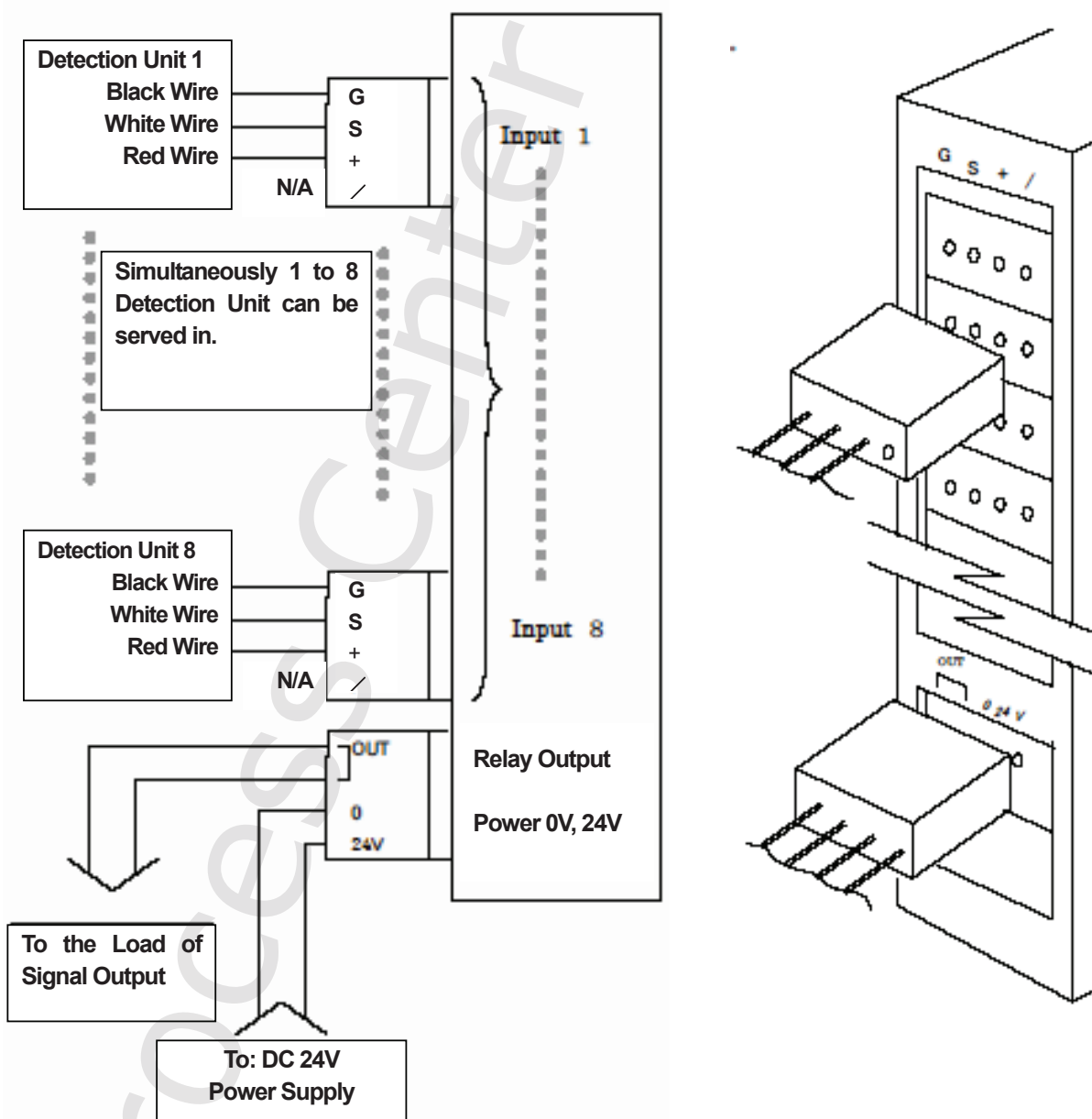

\* The output of the Control Unit is one relay contact only.





## Manual Läckagelarm / Vätskelarm RS-3000

### 4. Operation

**WARNING:** *The following procedure must be implemented after wiring has done and prior to operation.*

#### 4-1. Detection Unit without Control Unit

**Both of RS-3000FA and RS-3000FAP is the same wiring feature.**

- (1) After required installation and the wiring have completed, turn on the power. At this moment, Green LED on the Detection Unit will light while the other LED is off. And the output is ON status.

Next proceed either [1] for RS-3000FA or [2] RS-3000FAP as your application.

##### [1] RS-3000FA

Then the absorbent paper will be removed from the Bracket temporarily. The LED of the Detection Unit will change the color to Red. The output will become OFF simultaneously. Verify these things happen.

After then, the absorbent paper must be set again. The sensor is now ready for use.

##### [2] RS-3000FAP

Then pour a drip of water for the test into the close area of the Detection Unit. Upon the water absorbed by the paper, the LED of the Detection Unit will change its color into Red. The output of will become OFF simultaneously.

After then, wipe off the water completely and set the Detection Unit again in the Bracket.

#### 4-2. Control Unit RS-3000C and Detection Unit

**Both of RS-3000FA and RS-3000FAP is the same wiring feature.**

- (1) After required installation and the wiring have completed, turn on the power. The LED Display of Power will light on. Then set the Dip Switches on the Control Unit. The detailed function is described the chart in next page.

##### [Adjusting of Dip Switches]

Put the adequate number of the Dip Switch ON position same as the selected number of the input port of the Control Unit. For example, 5 of the Detection Unit are connected to the input port of 1 through 5, the Dip Switch of 1 through 5 must be turn ON position and other rest of 6 to 8 must be OFF position.

In case that the selected number of the Dip Switch may be OFF in spite the Detection Unit is connected at the same input number, the output signal from the Detection Unit will not be recognized, then both of the Green and Red LED Display on the Control Unit remain unlit.

- (2) Verify the status of all the Detection Unit connected in the Control Unit as described in the above 4.1 section.
- (3) When the Detection Unit shows Red LED on and its output is OFF, the LED Display of the Control Unit shows Red (Alarm) on for the selected number, and Relay contact of the output is OFF=Close.  
When all the Detection Unit shows Green LED, the Relay contact of the Control Unit is ON=Open.



# Manual Läckagelarm / Vätskelarm RS-3000

## Connection and Status Reference Chart

Input	Detection Unit	Dip Switch	LED Display	Relay Out
1	Green ON	n=ON	n = Green ON	OFF = Close
2	Red ON 1) Leakage 2) Floating position		n = Red ON	ON = Open
3	Not Connected		n = Red ON	ON = Open
4	Not Connected	N=OFF	n = unlit	OFF=Close

\* "n" represents selected input number from 1 to 8 of the Control Unit.

\* If the correspondent number of the Dip Switch may not be set correctly, the Relay output will not function accurately.

### 4-3. Distinction of the abnormal status

- (1) When the LED of the Detection Unit will not put on, wrong wiring or the damage of the unit by the short circuit of the output that causes the overload may be possible. Stop to use the unit, and check with the wiring and the load status.
- (2) On RS-3000FA, abnormally Red LED may light though the absorbent paper is located correctly or Green LED may light though the absorbent paper is not located, and on RS-3000FAP, abnormally Green LED may light though the test water penetrates into the detecting area, the Detection Unit may be damaged. Stop using the unit immediately, and consult the vendor or the factory.
- (3) When the incorrect output may be observed though the LED functions correctly, the unit may be damaged by wrong wiring or overloaded output at the output transistor inside. Check the wiring and the load.
- (4) When the Detecting Unit is not placed far into the Bracket as its position, the LED will light Red and output turns OFF. Check the location of the Detecting unit with its Bracket again, and adjust it if placement is wrong.
- (5) When RS03000C Control Unit is applied, be aware that the output of the unit is provided in one pole only in spite the Detection Unit may be served two or more. When one among those connected Detecting Units may turns the output OFF, the singular relay output of the Control Unit becomes ON=Open.

All the Dip Switch must be set correctly as instructed before in this manual.

**NOTE:** The RS-3000 series sensors utilize the optical devices, and the highly intensive light from outwards (over 1,000 luxes) may disable the function of the Detecting Unit. The normal intensity like the room light may not affects critically, however for safety, you are recommended to avoid any devices which emit the intensive light from the Detection Unit neighborhood, or to shade the light by means of anything applicable.



## Manual Läckagelarm / Vätskelarm RS-3000

### 5. Reset Procedure after Alarm Clearance

**WARNING:** *The liquid may contain hazardous acids, alkalis, or chemical substances. The following procedure has to be done by a well-trained person who is knowledgeable for that liquid.*

**NOTE:** *The protection gloves must be worn.*

**NOTE:** *In case of handling any chemicals that are obliged to wear the protection goggles, masks, etc. by regulation, must follow the regulation.*

- (1) Turn off the power..
- (2) Remove the Detection Unit from the Bracket, and wipe the liquid off.
- (3) Remove the wet Absorbent Paper and wipe the Bracket and surroundings. Replace with a new paper then reset to follow the process of Installation of the Detection Unit.
- (4) If the absorbent paper is not applied, wipe the unit, the Bracket and the surroundings. Then reset to follow the process of installation section in this manual.
- (5) Turn on the power again then the reset is completed..
- (6) Check the function of the sensors with the steps of the Section 4.1 to 4.2. Operation
- (7) Achieve periodical maintenance check of the sensor.

As the material of the absorbent paper is cellulose, then periodical replacement of the paper is recommended if the sensor is located for a respectively long time.

**NOTE:** *The periodical check is recommended at least annually, in accordance with your factory direction.*

**WARNING:** *This sensor is not explosion proof. Do not use in the area where explosion proof is specified.*

Process

**Manual Läckagelarm / Vätskelarm RS-3000**

www.processcenter.se

**6. Specification****6-1. Detection Unit**

Model	RS-3000FA	RS-3000FAP
Supply Voltage	DC 12~24V ±10%	
Current	20mA below	
Indication of LED	Leakage: Red, Floating position: Red, Normal: Green	
Output	NPN open collector, 50mA max (normal; ON)	
Ambient Temp.	-10~60°C	
Material	Case	PFA
	Cable	FEP, 3-wire sheath
	Lamp	Epoxy (embedded)
Water Protect	Sealed, IP 67 equivalent (IEC)	
Weight	Approx 40g	
Absorbent Paper	Required	Not Required
Bracket	P/N-6430	P/N-6720B

**6-2. Control Unit**

Model	RS-3000C
Input Voltage	24V DC ± 10%
Power Consumption	200mA below
Input	Simultaneously 1 to 8 Input available
LED Display	Independent LED Display for every Input Number( Red, Green x 8) Normal: Green, Leakage: Red No Connection: Unlit both Green and Red
Output	Relay Output × 1 Normal Status: Close, Leakage or Alarm: Open, Power Failure: Open
Ambient Temp.	-10~60°C environment
Case Material	ABS Polymer
Cable connection	Input: 8 Connector ports (Lock feature) Power & Output: 1 Connector port (Lock feature)
Installation	DIN Rail installation, Screw fix up
Wiring Error	Cut circuit detection feature available
Applicable Detection Unit	RS-3000FA, RS-3000FAP; RS-3000FA-BZ*, RS-3000FAP-BZ* (* marked models are Buzzer Alarm Leak Sensor)

\* The adopted Connector to the Control Unit is OMRON, XN2A-1430.