

Manual Flödesmätare Ultraljud LRF-3000S (Energi)

www.processcenter.se

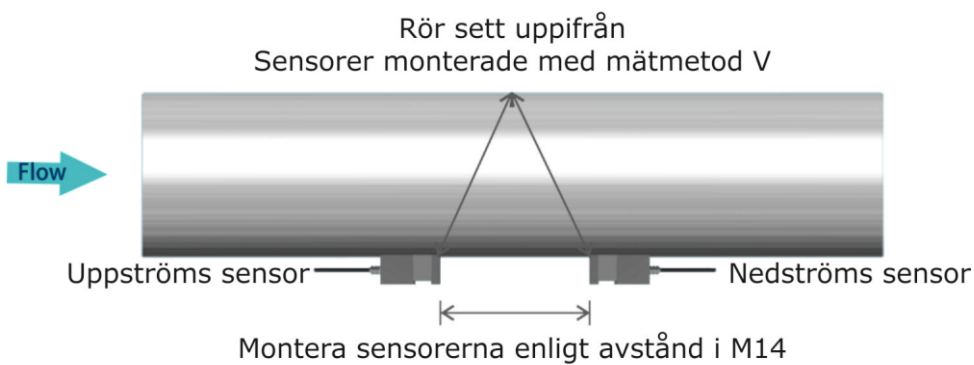

Notice

Thank you for choosing the LRF-3000S Ultrasonic Flow meter.

Please read the instruction manual carefully before you use the flow meter to avoid the damage to the flow meter or improper use.



Warning

May cause injury.



Attention

May damage the flow meter.

Some of the instructions may be different to the flow meters you purchased, depending on configuration requirements, otherwise, there is no indication about the product design and upgrade requirement in the instructions, please refer to the version number, as well as the appendix.



Manual Flödesmätare Ultraljud LRF-3000S (Energi)

www.processcenter.se

Content

1.	Product Overview	4
1.1.	Introduction.....	4
1.2.	Features of LRF-3000S.....	4
1.3.	Theory of Operation.....	4
1.4.	Specifications.....	5
2.	Connection.....	6
2.1.	Wire Connecting.....	6
2.1.1.	Power supply option	6
2.1.2.	Transmitter Wiring.....	6
2.2.	Powering on.....	7
2.3.	Keypad Functions	8
2.4.	Keypad Operation.....	8
3.	Quick start.....	9
3.1.	Basic settings	9
3.2.	Measurement Site Selection.....	10
4.	Transducer Installation	13
4.1.	Transducer Installation.....	13
4.1.1.	Transducer Spacing.....	13
4.1.2.	Transducer Mounting Methods.....	13
4.1.3.	V Method	13
4.1.4.	Z Method	14
4.2.	Transducer Mounting Inspection	14
4.2.1.	Signal Strength.....	15
4.2.2.	Signal Quality (Q value).....	15
4.2.3.	Total Time and Delta Time	15
4.2.4.	Transit Time Ratio	15
4.2.5.	Warnings	16
5.	Operating Instructions	17
5.1.	System Normal Identification.....	17
5.2.	Low Flow Cutoff Value	17
5.3.	Zero Settings.....	17
5.4.	Scale Factor	17
5.5.	System Lock	18
5.6.	4 ~ 20mA Current Loop Output.....	18



Manual Flödesmätare Ultraljud LRF-3000S (Energi)

www.processcenter.se

5.7.	Frequency Output	18
5.8.	Totalizer Pulse Output	19
5.9.	Alarm Programming	19
5.10.	4-20mA Analog Output Calibration.....	19
5.11.	SD Card Operation	20
5.1.1.	Specifications.....	20
5.1.2.	Install or Remove the SD card while the meter is powered on.....	20
5.1.3.	ESN.....	21
6.	Windows Display Explanations	22
6.1.	Windows Display Codes.....	22
6.2.	Display Explanations	24
7.	Error Diagnoses	44
7.1.	Table 1. Error Codes and Solutions (during operation)	44
7.2.	Frequently Asked Questions and Answers.....	45
8.	Appendix3 – Serial Interface Network Use and Communications Protocol.....	46
8.1.	Overview.....	46
8.2.	Serial port definitions.....	46
8.3.	Direct connection via RS232 to the host device	47
8.4.	Communications protocol and the use.....	47
8.4.1.	HL Protocol.....	47
8.4.2.	MODBUS-I Communication Protocol.....	49
9.	Appendix6 - Flow Application Data.....	55
9.1.	Sound Velocity for Various Materials Commonly Used	55
9.2.	Sound Velocity in Water (1 atm) at different temperatures	56

Update Information:

1. Product Overview

1.1. Introduction

LRF-3000S is a wall-mount, clamp- on type ultrasonic flow meter which uses the transfer time technology. Clamp on type ultrasonic flow meter is easy to install and no need to cut off the pipe that saves you lots of troubles and cost. At the same time LRF-3000S has our unique calculate software to ensure the high accuracy and low velocity response.

LRF-3000S ultrasonic flow meter widely application in oil industry, water treatment, pure water, chemical and etc.

LRF-3000S could add the RTD model and temperature sensor become an energy meter to monitoring the energy use, help to save the energy.

1.2. Features of LRF-3000S

Comparing With other traditional flow meter or ultrasonic flow meter, it has distinctive features such as high precision, high reliability, high capability and low cost, the Flow meter features other advantages:

1. With ARM COMA chip, low power consumption, high reliability, anti-jamming and outstanding benefits.
2. User-friendly menu designed. Parameters of pipe range, pipe material, pipe wall thickness, output signals, etc can be conveniently entered via the windows. British and Metric measurement units are available.
3. Daily, monthly and yearly totalized flow: Totalized flow for the last 64 days and months as well as for the last 6 years are may be viewed. With the SD Card, 512 files can be stored; the time interval can be within 1 second.
4. Parallel operation of positive, negative and net flow totalizer with scale factor and 7 digit display. Internally configured batch controller makes batch control convenient.

The flow meter ensures the higher resolution and wider measuring range by the 0.04ns high resolution, high linearity and high stability time measuring circuit and 32 bits digits processing program.

1.3. Theory of Operation

$$V = \frac{MD}{\sin 2\theta} \times \frac{\Delta T}{T_{up} \cdot T_{down}}$$

Remarks:

V Medium Velocity

M Ultrasonic frequency of reflection

D Pipe Diameter

θ The angle between the ultrasonic signal and the flow

T_{up} Transit time in the forward direction

T_{down} Transit time in the reverse direction

$\Delta T = T_{up} - T_{down}$

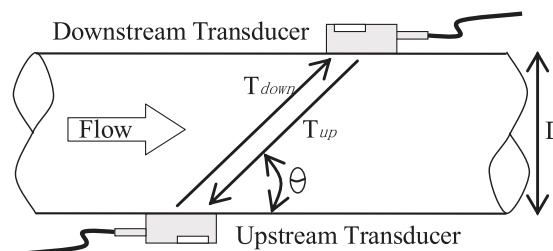

Manual Flödesmätare Ultraljud LRF-3000S (Energi)

www.processcenter.se

1.4. Specifications

Performance specifications	
Flow Range	0 ft/s ~ ± 40 ft/s (0 m/s ~ ± 12 m/s).
Accuracy	± 1.0% of measured value.
Repeatability	0.2%.
Pipe Size	1" ~ 48" (25 mm ~ 1200 mm).
Function Specifications	
Output	Analog output: 0/4 ~ 20 mA, (max load 750 Ω); Pulse output: 0 ~ 9999 Hz, OCT (min. and max. frequency is adjustable); Relay output: max. Frequency 1Hz (1A@125VAC or 2A@30VDC).
Communication Interface	RS232 & RS485.
SD Card (Option)	Max record: 512 days. Record time interval: 1 ~ 3600 s.
Power Supply	10 ~ 36 VDC/AC90~245V.
Keypad	16 light tactile keys.
Display	240*128 lattice, backlit LCD.
Temperature	Transmitter: -40°F ~ 140 °F (- 40°C ~ 60°C). Transducer: -40 °F ~ 176 °F (- 40 °C ~ 80 °C, standard).
Humidity	Up to 0 ~ 99% RH, non - condensing.
Physical specifications	
Transmitter	PC/ABS, IP65.
Transducer	Encapsulated design. Standard / Maximum cable length: 30 ft / 1000 ft (9m / 305 m).
Weight	20*22*23.5cm, 3.2kg

2. Connection

2.1. Wire Connecting

2.1.1. Power supply option

Customers should pay special attention to specify the desired power supply when wiring.

Factory standard power supply is 10~36VDC/1A max.

To ensure the transmitter can work normally, please pay attention to the followings when wiring:

Ensure that power connections are made in accordance with the specifications shown on the transmitter.

2.1.2. Transmitter Wiring

Once the electronics enclosure has been installed, the flow meter wiring can be connected.

Open the case, you will find the Power board wiring ports, from left to right, are as follows;

Connect to power supplier, Relay Output, OCT Output, Transducer wiring, 4-20mA Output, RS232 Output, RS485 Output, Analog Input.

For double-shielded transducer cable: "-" on the Blue wire, "+" on the Brown wire and "shield" on the Black shield wire.

Refer to the below form for specific connection:

Sign	Description
L	AC Power AC90~245V
N	
	Grounding
DC+	DC Power DC10~36V +
DC-	DC Power DC10~36V -
RL OUT+	Relay Output
RL OUT-	
GND	Upstream sensor Grounding Black
UP+	Upstream sensor + Brown
UP-	Upstream sensor - Blue
GND	Downstream sensor Grounding Black
DN+	Downstream sensor + Brown
DN-	Downstream sensor - Blue

Manual Flödesmätare Ultraljud LRF-3000S (Energi)

www.processcenter.se

OCT OUT+	OCT Output
OCT OUT-	
I OUT+	40~20mA Output
I OUT-	
AI1	Analog Signal Input (Only Energy Meter)
AI2	
GND	
TX	RS232 Output
RX	
GND	
A	RS485 Output
B	
IN1+	Temperature sensor water inline +
IN1-	Temperature sensor water inline -
GND	Temperature sensor water inline grounding
IN2+	Temperature sensor water outline +
IN2-	Temperature sensor water outline -
GND	Temperature sensor water outline grounding



Warning

Wire when it is power-off. Reliable grounding must be taken for the instrument before installation and use.

Use either AC or DC power supply. Do not connect them both at the same time.

2.2. Powering on

As soon as the flow meter is switched on, the system will run automatically according to the last input parameters. If the installation is accomplished when system is switched on, gain adjustment can be monitored in Window M04. After code "*R" are displayed on the upper right corner of the screen, the system will activate the normal measurement condition automatically. It is indicated by code "*R" on the upper left corner of the screen.

If it is the first time to use or install on a new site, the customer need to input the new installation site parameters. Any parameters which are set by user will be saved permanently until they are changed by the user.

When the user modifies the parameters and removes the transducers, the meter will recalculate automatically, and operate normally with the parameters.

The flow meter can always complete all tasks at the same time. The tasks (Including measurement, output, etc) will be carried out as usual, no matter in which display window.

2.3. Keypad Functions



Numbers “0~9” and “.” Input Numbers or Menu Code



“” Backspace or delete characters to the left or back to the previous menu.



“ ” Return to the last menu or open the next menu. Acts as “+” and “-” are used to enter numbers.

“ Menu” Select a menu. Press this key first, then input two menu numbers to display the selected menu.

2.4. Keypad Operation

The flow meter adopts the window software design to consolidate or subdivide all of the parameters entered, the instrument setup and measurement result displays into independent windows. The operator can input parameters, modify settings or display measurement results by “visiting” a specific menu window. Each window serial number, or so-called window ID code, has a defined meaning. For example, Window M10 indicates the parameter input for pipe outside diameter, while Window M14 indicates the mounting spacing between the transducers, etc. (Refer – Windows Display Explanations).



The keypad shortcut to visit a specific window is to press the “ Menu” key at any time, then input the 2-digit window ID code. For example, to input or check the pipe outside diameter, just press the “ Menu” “1” “0” keys for window ID code 10. Use “” and “” to switch.

Another method to visit a particular window is to press “” and “” to scroll the screen.

You can check the corresponding parameters by visiting the Data Type Windows. If you want to modify the parameters, press “ Enter ” first, input the digits then press “ Enter ” again to confirm.

Attention



Generally, press  key first if operator wants to enter “modify” status. If the “modify” is still not possible even after pressing the  key, it means that system is locked by a password. To “Unlock” it, select “Unlock” in Window M54 and enter the original password.

3. Quick start

3.1. Basic settings

For example, let us you have a pipe of 200mm outer diameter, 4mm pipe thickness, measuring medium is water, Pipe Material is PVC with no Liner, These parameters should be operated as follows:

Step1. Pipe Size Settings

Find M10; enter the pipe size, the outer diameter of the pipe and the pipe thickness.

Press the “ Enter” to confirm.

M10	Pipe settings	*R
Size	M.	
OD	200.0	mm
thk	4.0	mm

Step2. Pipe Material

Use “” to switch to select the material of the pipe.

Press the “ Enter” to confirm.

M10	Pipe settings	*R
Size	M.	
M.	0.PVC	
Other	3200	m/s

Step 3. Water Temperature

Find M12, select the temperature of the water, temperature should be 0-80 deg. C.

Press the “ Enter” to confirm.

Note: Room temperature is 25 deg.C

M12	Medium	*R
WTMP	20	(° C)

Manual Flödesmätare Ultraljud LRF-3000S (Energi)

www.processcenter.se

Step 4. Transducer Type

Find M13, select the transducer type, here we select the 1. Clamp-On-D, our standard clamp on type transducer.

Press the “ Enter” to confirm.

M13	Ttransducer	*R
Type	Method	Mode
Option	0.Clamp-On	

Step 5. Transducer Mounting Methods

Use “” to switch to select transducers mounting method, here we select 0. V type, directly method. Press the “ Enter” to confirm.

M13	Ttransducer	*R
Type	Method	Mode
Option	0.V	

Step 6. Installation Spacing

Find M14, accurately install the transducer according to the displayed transducer mounting spacing and the selected mounting method.

M14	INSTL Spacing	*R
Value	154.2	mm

Step 7. Display Measurement Results

Menu 01 will display flow rate. (Subject to the real measurement.)

M01	Flow Rate	*R
Flow	Vel.	
100.2		m ³ /h

3.2. Measurement Site Selection

The installation of this ultrasonic flow meter is the simplest one of all kinds of flow meters. Only one suitable measuring site needed, plug the transducers on the pipe and then start the measurement.

When selecting a measurement site, it is important to select an area where the fluid flow profile is fully developed to guarantee a highly accurate measurement. Use the following guidelines to select a proper installation site:

- Choose a section of pipe that is always full of liquid, such as a vertical pipe with flow in the upward direction or a full horizontal pipe.



Manual Flödesmätare Ultraljud LRF-3000S (Energi)

www.processcenter.se

- Ensure enough straight pipe length at least equal to the figure shown below for the upstream and downstream transducers installation. Try to avoid Ensure enough straight pipe length at least equal to the figure shown below for the upstream and downstream transducers installation.
- On the horizontal pipe, the transducer should be mounted on the 9 and 3 of the pipe, avoiding the position of 6 and 12, in case of the signal attenuation caused by pipe at the bottom sediment or bubble, cavitation on the pipe.
- Ensure that the measuring site temperature is under the transducer temperature limits.
- Consider the inside condition of the pipe carefully. If possible, select a section of pipe where the inside is free of excessive corrosion or scaling.
- Choose a section of sound conducting pipe.

Manual Flödesmätare Ultraljud LRF-3000S (Energi)

www.processcenter.se

90° Bend

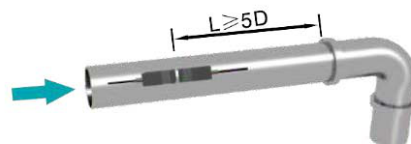
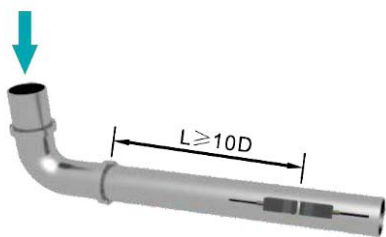

Tee

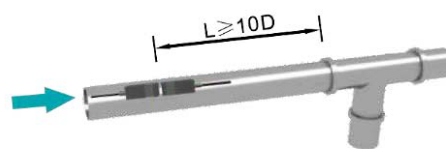
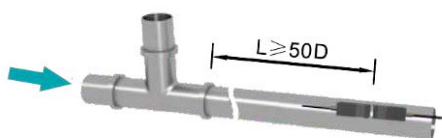

Diffuser

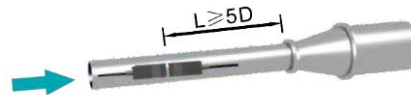
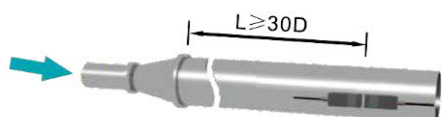

Reduce

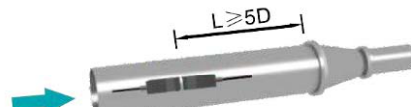
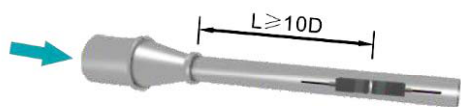

Valve

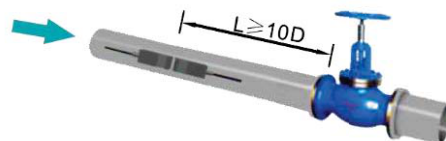
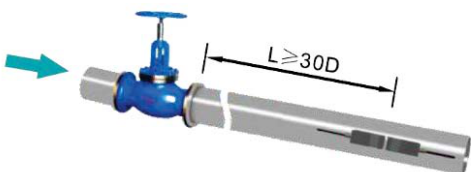

Vertical

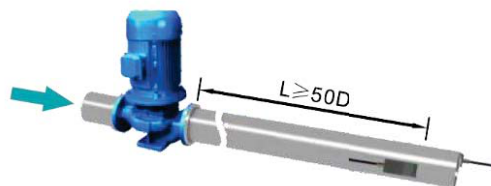
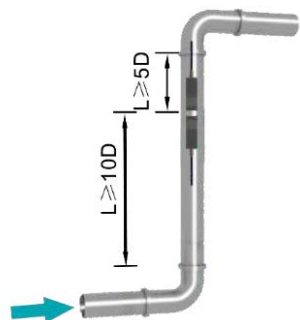

4. Transducer Installation

4.1. Transducer Installation

Please make sure the pipe surfaces where the transducers are to be mounted are all clean. Including the rust, scale or loose paint to have a smooth surface. Choose the section and don't forget apply the coupling compound. Apply the coupling compound down the center of the face of each transducer as well as on the pipe surface, ensure there are no air bubbles between the transducers and the pipe wall, and then attach the transducers to the pipe with the straps provided and tighten them securely.

Note: The two transducers should be mounted at the pipe's centerline on horizontal pipes.

Make sure that the transducer mounting direction is parallel with the flow.

During the installation, there should be no air bubbles or particles between the transducer and the pipe wall. On horizontal pipes, the transducers should be mounted in the 3 o'clock and 9 o'clock positions of the pipe section in order to avoid any air bubbles inside the top portion of the pipe. (Refer to Transducer Mounting). If the transducers cannot be mounted horizontally symmetrically due to limitation of the local installation conditions, it may be necessary to mount the transducers at a location where there is a guaranteed full pipe condition (the pipe is always full of liquid).

4.1.1. Transducer Spacing

The spacing between the ENDS of the two transducers is considered as the standard transducer spacing (Refer to MENU14). After entering the required parameters, Check the data displayed in Window M14 and adjusted the transducers spacing according to the data displayed in Windows M14.

1.1.2 Transducer Mounting Methods

There are two mounting method, you could use depend on the measuring environment.

V method and Z method (Reflect method and Direct method).

V method is easy to installation and fit for mostly ultrasonic environment but Z method has stronger signal and works better in the complicated measuring environment.

4.1.3. V Method

The V method is considered as the standard method. It is convenient to use, but still requires proper installation of the transducers, contact on the pipe at the pipe's centerline and equal spacing on either side of the centerline.

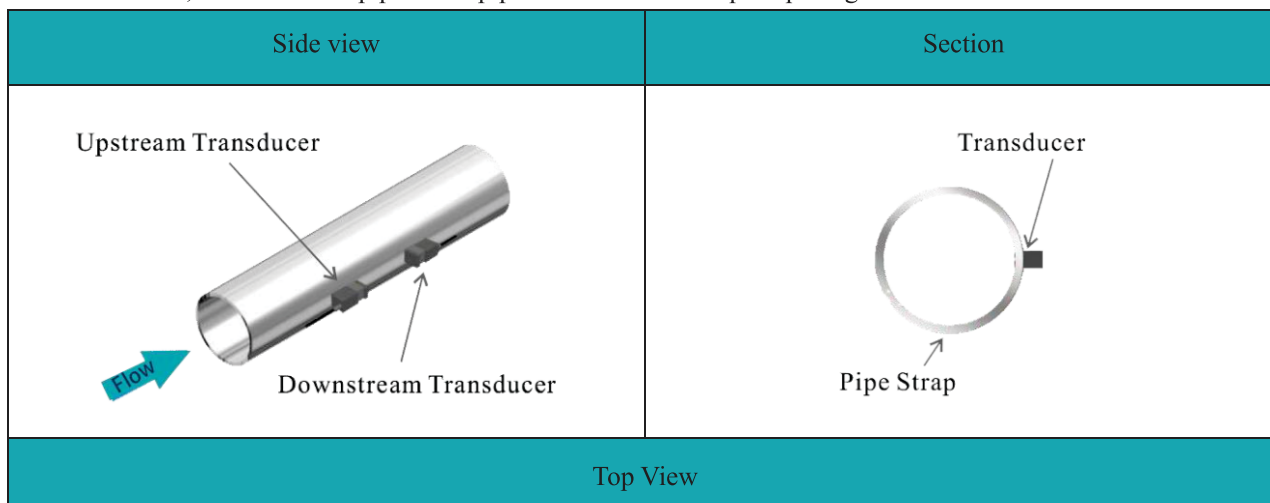

Manual Flödesmätare Ultraljud LRF-3000S (Energi)

www.processcenter.se

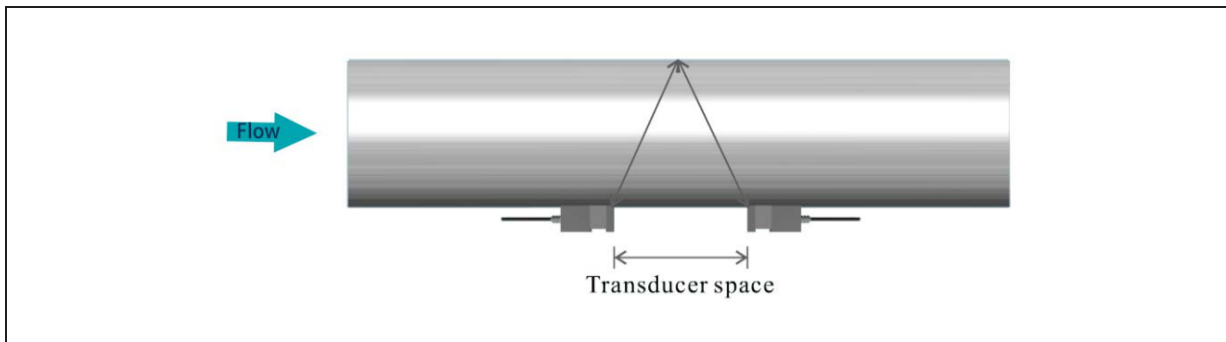

4.1.4. Z Method

The signal transmitted in a Z method installation has less attenuation than a signal transmitted with the V method. When the pipes are too large, there are some suspended solids in the fluid, or the scaling and liner are too thick. This is because the Z method utilizes a directly transmitted (rather than reflected) signaling which transverses the liquid only once. The Z method is able to measure on pipe diameters ranging from 100mm to 5000mm (4 inch to 200 inch) approximately. Therefore, we recommend the Z method for pipe diameters over 300mm (12 inch).

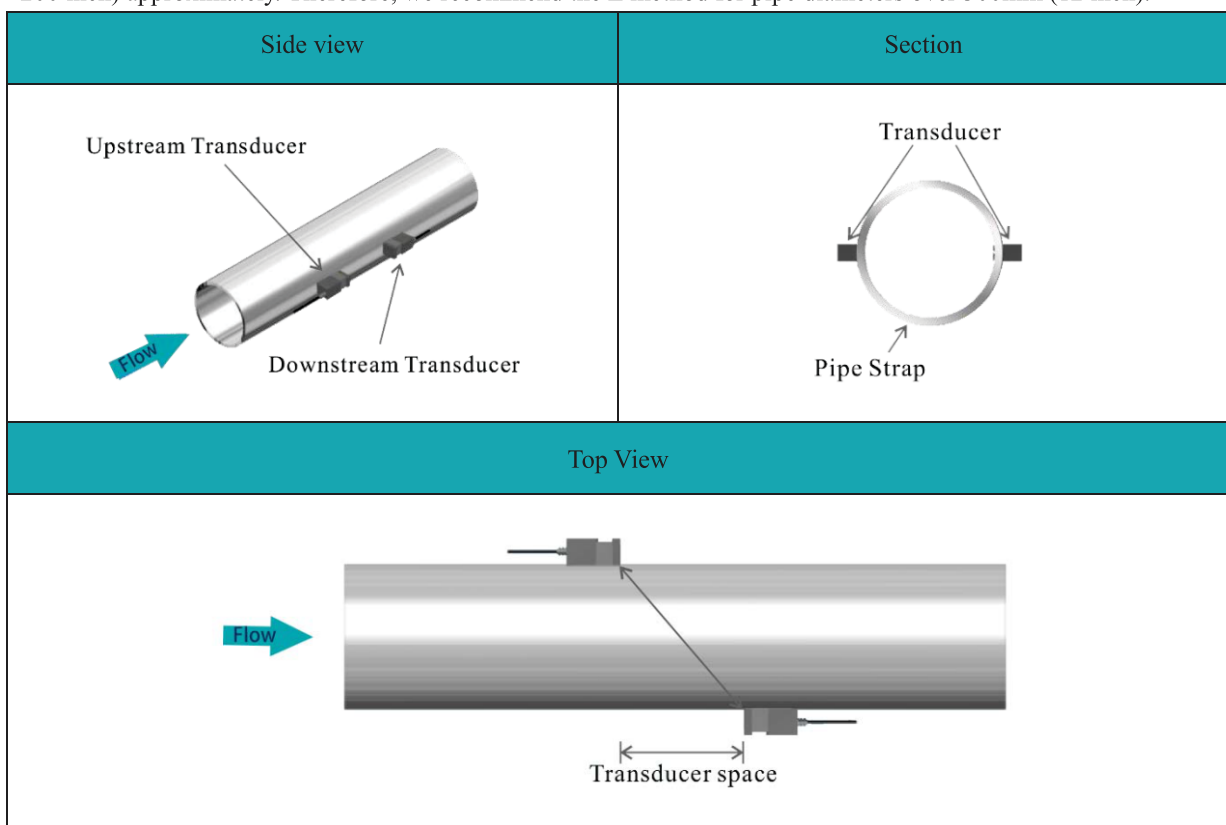

4.2. Transducer Mounting Inspection

Check to see if the transducer is installed properly and if there is an accurate and strong enough ultrasonic signal to ensure proper operation and high reliability of the transducer. It can be confirmed by checking the detected

Manual Flödesmätare Ultraljud LRF-3000S (Energi)

www.processcenter.se

signal strength, total transit time, delta time as well as transit time ratio.

The "mounting" condition directly influences the flow value accuracy and system long-time running reliability. In most instances, only apply a wide band of sonic coupling compound lengthwise on the face of the transducer and stick it to the outside pipe wall to get good measurement results. However, the following inspections still need to be carried out in order to ensure the high reliability of the measurement and long-term operation of the instrument.

4.2.1. Signal Strength

Signal strength (displayed in Window M04) indicates a detected strength of the signal both from upstream and downstream directions. The relevant signal strength is indicated by numbers from 00.0 ~ 99.9. 00.0 represents no signal detected while 99.9 represent maximum signal strength. Normally, the stronger the signal strength detected, the longer the operation of the instrument reliably, as well as the more stable the measurement value obtained.

Adjust the transducer to the best position and check to ensure that enough sonic coupling compounds is applied adequately during installation in order to obtain the maximum signal strength.

System normally requires signal strength over 75.0, which is detected from both upstream and downstream directions. If the signal strength detected is too low, the transducer installation position and the transducer mounting spacing should be re-adjusted and the pipe should be re-inspected. If necessary, change the mounting method to be Z method.

4.2.2. Signal Quality (Q value)

Q value is short for Signal Quality (displayed in Window M04). It indicates the level of the signal detected. Q value is indicated by numbers from 00 ~ 99. 00 represents the minimum signal detected while 99 represent the maximum. Normally, the transducer position should be adjusted repeatedly and coupling compound application should be checked frequently until the signal quality detected is as strong as possible.

4.2.3. Total Time and Delta Time

"Total Time and Delta Time", which displays in Window M04, indicates the condition of the installation. The measurement calculations in the Flow meter are based upon these two parameters. Therefore, when "Delta Time" fluctuates widely, the flow and velocities fluctuate accordingly, this means that the signal quality detected is too poor. It may be the resulted of poor pipe-installation conditions, inadequate transducer installation or incorrect parameter input.

Generally, "Delta Time" fluctuation should be less than $\pm 20\%$. Only when the pipe diameter is too small or velocity is too low can the fluctuation be wider.

4.2.4. Transit Time Ratio

Transit Time Ratio indicates if the transducer mounting spacing is accurate. The normal transit time ratio should be $100 \pm 3\%$ if the installation is proper. Check it in Window M04.

Attention

If the transit time ratio is over $100 \pm 3\%$, it is necessary to check:



- (1) If the parameters (pipe outside diameter, wall thickness, pipe material, liner, etc.) have been entered correctly,
 - (2) If the transducer mounting spacing is accordance with the display in Window M14,
 - (3) If the transducer is mounted at the pipe's centerline on the same diameter,
 - (4) If the scale is too thick or the pipe mounting is distorted in shape, etc.
-

4.2.5. Warnings

- (1) Pipe parameters entered must be accurate; otherwise the Flow meter will not work properly.
- (2) During the installation, apply enough coupling compounds in order to stick the transducers onto the pipe wall. While checking the signal strength and Q value, move the transducers slowly around the mounting site until the strongest signal and maximum Q value can be obtained. Make sure that the larger the pipe diameter, the more the transducers should be moved.
- (3) Check to be sure the mounting spacing is accordance with the display in Window M14 and the transducer is mounted at the pipe's centerline on the same diameter.
- (4) Pay special attention to those pipes that formed by steel rolls (pipe with seams), since such pipe is always irregular. If the signal strength is always displayed as 0.00, that means there is no signal detected. Thus, it is necessary to check that the parameters (including all the pipe parameters) have been entered accurately. Check to be sure the transducer mounting method has been selected properly, the pipe is not worn-out, and the liner is not too thick. Make sure there is indeed fluid in the pipe or the transducer is not too close to a valve or elbow, and there are not too many air bubbles in the fluid, etc. With the exception of these reasons, if there is still no signal detected, the measurement site has to be changed.
- (5) Make sure that the Flow meter is able to run properly with high reliability. The stronger the signal strength displayed, the higher the Q value reached. The longer the Flow meter runs accurately, the higher the reliability of the flow rates displayed. If there is interference from ambient electromagnetic waves or the signal detected is too poor, the flow value displayed is not reliable; consequently, the capability for reliable operation is reduced.
- (6) After the installation is complete, power on the instrument and check the result accordingly.

5. Operating Instructions

5.1. System Normal Identification

If the letter "*R" displays on the screen, it indicates system normal.

If the letter "D" is displayed, it indicates that system is adjusting the signal gain prior to the measurement. Also, it means system normal. Only when the adjustment takes too long without stopping, can system be identified as abnormal.

Letter "E" indicates no signal is being detected. Check the transducer wiring connections are correct, the transducers are installed firmly, etc.

For further information, please refer to "Error Diagnosis".

5.2. Low Flow Cutoff Value

The data in M21 is Low Flow Cutoff Value. If the flow rate falls below the low flow cutoff value, the flow indication is driven to zero. This function can prevent the flow meter from displaying flow as "0" after a pump was shut down, but there is still liquid movement in the pipe, which will result in cumulative error. Generally, 0.03m/s is recommended to enter as the low flow cutoff point.

The low flow cutoff value has no relation to the measurement results once the velocity increases over the low flow cutoff value.

5.3. Zero Settings

Once zero flow occurs, a zero point may indicate on each measuring instrument, but the displayed measuring value is not equal to "0", this value indicates "Zero". To any measuring instrument, the smaller the "Zero" is, the better the quality is. Conversely, if the Zero is too big, that indicates the quality of the instrument is poor.

If the zero set point is not at true zero flow, a measurement difference may occur. The smaller the physical measurement capacity is, the larger the measurement difference from the zero point will exist. Only when zero point reduced to a definite degree, as compared with the physical measurement capacity, can the measuring difference from zero point be ignored.

For an ultrasonic Flow meter, the measurement error from zero point cannot be ignored under low flow conditions. It is necessary to perform a static zero set calibration to improve low flow measurement accuracy.

Cutoff Zero

In Window M22- Cutoff- 1. Yes, window will show the "success" and back to M01 when you cut off the zero point successfully.

Performing Set Zero

In Window M22- Reset

5.4. Scale Factor

Scale factor refers to the ratio between "actual value" and "reading value". For example, when the measurement is 2.00, and it is indicated as 1.98 on the instrument, the scale factor reading is 2/1.98. This means that the best scale factor constant is 1. However, it is difficult to keep the scale factor as "1" on the instrument especially in batch productions. The difference is called "consistency".

During operation, there still exists possible difference in pipe parameters, etc. The "scale factor" may be necessary when used on different pipes. Thus, scale factor calibration is specially designed for calibrating the differences that result from application on different pipes. The scale factor entered must be one that results from actual flow calibration. The scale factor can be input in Window M26.

Manual Flödesmätare Ultraljud LRF-3000S (Energi)

www.processcenter.se

5.5. System Lock

System lock is intended to prevent operation error due to tampering by unauthorized personnel.

M54 is for system lock, unlock it by using the selected password only. If "lock" is displayed on the screen, then enter the correct password.

Keep the password in mind or recorded in a safe place, otherwise the instrument cannot be used.

5.6. 4 ~ 20mA Current Loop Output

With a current loop output exceeding an accuracy of 0.1%, the flow meter is programmable and configurable with outputs such as 4 ~ 20mA or 0 ~ 20mA selected in Menu 32. For details, please refer to Menu 32 in "Window Display Explanations".

In Window M32- Range- LowL, enter a 4mA flow value. Enter the 20mA flow value in Window M32-Range-UpperL. For example, if the flow range in a specific pipe is 0 ~ 1000m³/h, enter 0 in Window M32 and 1000 in Window M32. If the flow ranges from -1000 ~ 0 ~ 2000m³/h, configure the 20 ~ 4 ~ 20mA output by selecting in Window M32 when flow direction is not an issue. Enter 1000 in Window M32 LowL and 2000 in Window M32 UpperL. When flow direction is an issue, module 0 ~ 4 ~ 20mA is available. When the flow direction displays as negative, the current output is in range of 0 ~ 4mA, whereas the 4 ~ 20mA is for the positive direction. The output module options are displayed in Window M32.

Calibrating and testing the current loop is performed in Window M32-Check. Complete the steps as follows:

Use "↑" and "↓" to switch. "check 4mA", "check 8mA", "check 16mA", "check 20mA" readings, connect an ammeter to test the current loop output and calculate the difference. Calibrate the 4-20mA is in M62.

5.7. Frequency Output

The flow meter is provided with a frequency output transmitter function. The high or low frequency output displayed indicates the high or low flow rate reading. The user can reset the frequency output as well as flow rate as the user's actual requirements.

For example: if a pipe flow range is 0 ~ 5000m³/h, the relative frequency output required is 100 ~ 1000Hz, and the configuration is as follows:

In Window M33-Range-LowerL (lower limit frequency output flow value), input 0;

In Window M33-Range -UpperL (upper limit frequency output flow value), input 5000;

In Window M33-Mode-Frange(frequency range), input 100、 1000;

In Window M33-Mode-Option, select "a.Flow Rate";

Typical OCT Output wiring diagram as below:

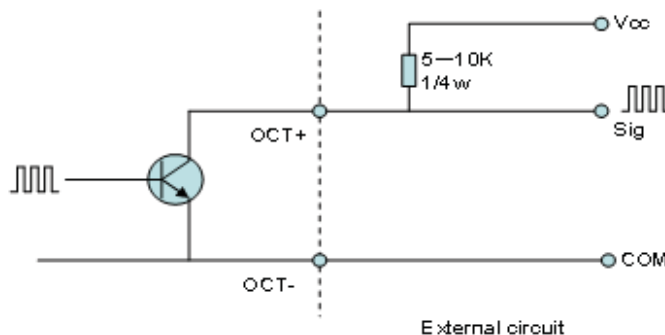

OCT Output wiring diagram

5.8. Totalizer Pulse Output

Each time the flow meter reaches a unit flow, it may generate a totalizer pulse output to a remote counter.

The totalizer pulse output can be transmitted through OCT or a relay. Therefore, it is necessary to configure OCT and the relay accordingly. (Please refer to Window M33 and M34). For example, if it is necessary to transmit the positive totalizer pulse through a relay, and each pulse represents a flow of 10m³, the configuration is as follows:

In Window M41-Unit, select the totalizer flow unit "m³";

In Window M41-MULT, select the scale factor "e. x10";

In Window M34-Option, select "g. POS Total";



Attention

Make sure to select an appropriate totalizer pulse. If the totalizer pulse is too big, the output cycle will be too long; if the totalizer is too small, the relay will operate too faster, you may shorten the life of the relay, as well as skip some pulses. The totalizer is recommended to transmit within the range of 1 ~ 3 pulse per second.

5.9. Alarm Programming

The on-off output alarm is generated through OCT or transmission to an external circuit by opening or closing a relay. The on-off output signal is activated under the following conditions:

- (1) Signal not detected;
- (2) Poor signal detected;
- (3) The flow meter is not ready for normal measurement;
- (4) The flow is in the reverse direction (back flow).
- (5) The analog outputs exceed span by 120%.
- (6) The frequency output exceeds span by 120%.
- (7) The flow rate exceeds the ranges configured (Configure the flow ranges using the software alarm system. There are two software alarms: Alarm#1 and Alarm #2).

Example 1: When flow rate exceeds 300 ~ 1000 m³/h, in order to program the relay output alarm, Complete the steps as follows:

- (1) In Menu 35, Alarm1 LowL 300;
- (2) In Menu 35, Alarm1 Upper 1000;
- (3) In Menu 34, Relay Setting-Option-d.Alarm1

5.10. 4-20mA Analog Output Calibration





Attention

Each flow meter has been calibrated strictly before leaving factory. It is unnecessary to carry out this step except when the current value (detected while calibrating the current loop) displayed in Window M32 is not identical with the actual output current value.

The hardware detect window must be activated prior to calibration the Analog Output. The procedure is as follows:



Menu 62 is for 4-20mA calibration, if you need enter the pass word to enter. With no effect to next power on, this window will close automatically as soon as the power is turned off.

Use “” and “” to switch. Calibrate the current loop 4mA output. Use an ammeter to measure the output current of current loop and adjust the displayed numbers at the same time. Watch the ammeter until it reads 4.00.

Manual Flödesmätare Ultraljud LRF-3000S (Energi)

www.processcenter.se

Stop at this point, the 4mA has been calibrated.

Use “” and “” to switch. Calibrate the current loop 20mA output. The method is the same as 4mA calibration.

The results are automatically saved in EEPROM and won't lose when power off.

5.11. SD Card Operation

6. SD card data memory is an optional.

5.1.1. Specifications

Data collection interval: any interval settings from 1 to 3600 seconds are OK according to the requirement.

Data content: date and time, flow rate, flow velocity, total flow, positive totalizer, negative totalizer.

Data storage format:

a=2017-11-16,16:21:12

b=+2.652471E+00 m3/h

c=+9.380460E-02 m/s

d=+3.520580E+02 m3

e=+3.520580E+02 m3

f=+0.000000E+00 m3

g=+0.000000E+00 GJ/h

h=+0.000000E+00 GJ

i=+0.000000E+00 GJ

j=+0.000000E+00`C

k=+0.000000E+00`CFile

system format: FAT16.

File type: plain text file (.TXT).

File number: maximum 512pcs.

It can save 120 bytes of data each time. If it is set to save once in per 5 seconds, the capacity of storing file in 24 hours is $120 \times 3600 / 5 \times 24 = 2073600 \text{ byte} \approx 2.1 \text{ Mbyte}$, therefore, 1Gbyte SD card can store for days: $1024 / 2.1 = 487.6 \approx 487$ days. When the capacity of the SD card is full, the new data will override the earliest files automatically.

5.1.2. Install or Remove the SD card while the meter is powered on

If the operator desires to insert the SD card with power on, please remove the power with power off. The following operation is to be used:



Attention:

Do not remove the SD card from the reader while actively working with the data. Data should be saved and stored in a separate location on the PC, and then processed from that file location. Processing the data directly from the SD card file location on the PC could result in losing or destroying data if the SD card is removed while still being processed.

5.1.3. ESN

We provide the flow meter with a unique electronic serial number to identify each flow meter for the convenience of the manufacturer and customers. The ESN, instrument types and versions are able to view in Window M50.



ATTENTION

Other Operating Refer to "6.2 Window Display Explanations".

6. Windows Display Explanations

6.1. Windows Display Codes

	Easy Introduction	A class of the menu
M0X	Display Value and Condition *R- System Normal *E - Signal Not Detected *D- Adjusting Gain	M00 Flow Totalizer
		M01 Flow Rate
		M02 Hot
		M03 Cool
		M04 Status
M1X	Installation Setting	M10 Pipe Settings
		M11 Lining Settings
		M12 Liquid Settings
		M13 Transducer Settings
		M14 Installation Space
M2X	Calibration Setting	M20 Damping
		M21 Low Flow Cut off Value
		M22 Zero Point Settings
		M23 Totalizer
		M24 Temperature
		M25 Power -off COMP
		M26 K Factor
		M27 Correction
		M28 SQA
M3X	Input and Output Settings	M30 Serial Port Parameter
		M31 AI Settings
		M32 CL Settings
		M33 OCT Settings
		M34 Relay Settings

Manual Flödesmätare Ultraljud LRF-3000S (Energi)

www.processcenter.se

M3X	Input and Output Settings	M35 Alarm Value Settings
		M36 Ration
		M37 Micro SD Settings (option)
M4X	Flow Unit Opinions	M40 Toggle Units
		M41 Flow Units
		M42 Energy Units
		M43 Temperature Units
M5X	System Settings	M50 Serial Number
		M51 Time and Date
		M52 Key Ton
		M53 Language
		M54 System Lock
		M55 System Reset
M6X	Others	M60 Date Totalizer
		M61 Running Timer
		M62 CL Adjust
		M63 RTD Adjust
		M64 AI Adjust

NOTE: The other menu features are retained by manufacturers.

Manual Flödesmätare Ultraljud LRF-3000S (Energi)

www.processcenter.se

6.2. Display Explanations

M00

Flow Total

Display Net Totalizer.

Display Positive totalizer.

Display Negative totalizer.

Use and to switch.

M00	Flow Total	*R
NET	POS	NEG
123.4		E+0 m ³

M00	Flow Total	*R
NET	POS	NEG
123.4		E+0 m ³

M01

Flow Rate

Display the Flow Rate and Flow Total

Display the Velocity.

* Flow Rate and the Flow Total switch every 6 seconds, Use the ENTER to stop the switch.

M01	Flow Rate	*R
100.2		m ³ /h
123.4		E+0 m ³

M01	Flow Rate	*R
2.1		m/s
123.4		E+0 m ³

Manual Flödesmätare Ultraljud LRF-3000S (Energi)

www.processcenter.se

M02

Heat Rate

Display the Heat Total.

Display the Heat Rate and the Inlet Water Temp and Outlet Water Temp.

NOTE:

Instrument needs energy capacity.

x 0.001 (E-3)	x 0.01(E-2)
x 0.1(E-1)	x 1(E+0)
x 10(E+1)	x 100(E+2)
x 1000(E+3)	x 10000(E+4)

* Heat Rate and the Heat Total switch every 6 seconds, Use the ENTER to stop the switch.

M02	Heat	*R
100.2		KW
234.5		E+0
		GJ

M02	Heat	*R
30.0	2.0	(° C)
234.5		E+0
		GJ

M03

Cool Rate

Display the Cool Total.

Display the Cool Rate and the Inlet Water Temp and Outlet Water Temp.

NOTE:

Instrument needs energy capacity.

x 0.001 (E-3)	x 0.01(E-2)
x 0.1(E-1)	x 1(E+0)
x 10(E+1)	x 100(E+2)
x 1000(E+3)	x 10000(E+4)

* Cool Rate and the Cool Total switch every 6 seconds, Use the ENTER to stop the switch.

M03	Cool	*R
100.2		KW
201.6		E+0
		GJ

M03	Cool	*R
9.0	-2.0	(° C)
201.6		E+0
		GJ

Manual Flödesmätare Ultraljud LRF-3000S (Energi)

www.processcenter.se

M04

Status

Display the Signal strength, the Upstream signal strength and Downstream signal strength.

Signal quality Q is indicated by 00 ~ 99. Therefore, 00 indicates the poorest signal while 99 indicates the best signal. Normally, signal quality Q value should be better than 60

Display the measured fluid sound velocity. Normally this value should be approximately equal to the entered value in Window M12. If the difference is too large, it probably results from an incorrect value entered in Window M12 or improper installation of the transducers.

Display the ratio between the actual measured transmit

time and the calculated transmit time according to customer's requirement. Normally the ratio should be $100 \pm 3\%$. If the difference is too large, the user should check that the parameters are entered correctly, especially the sound velocity of the fluid and the installation of the transducers.

This data is of no use before the system is ready.

Display the measured ultrasonic average time (unit: us) and delta time of the upstream and downstream (unit: ns) time. The velocity calculation in the flow meter is based on the two readings. The delta time is the best indication that the instrument is running steadily. Normally the fluctuation in the ratio of the delta time should be lower than 20%. If it is not, it is necessary to check if the transducers are installed properly or if the parameters have been entered correctly.

M04	Status	*R
Signal	Sound	Time
Up	Dn	Q
80.0	80.1	85

M04	Status	*R
Signal	Sound	Time
Vel.	1482	E+0
Ratio	100%	m ³

M04	Status	*R
Signal	Sound	Time
Total	185.0	us
Delta	30.5	ns

Manual Flödesmätare Ultraljud LRF-3000S (Energi)

www.processcenter.se

M10

Pipe settings

Enter the pipe outer diameter; the pipe outer diameter must range from 10mm to 1200mm.

Note: Enter Either pipe outer diameter or pipe outer perimeter

Enter the pipe wall thickness. Pipe wall thickness is necessary.

Enter pipe material. The following options are available:

0. PVC

1. CS Carbon Steel

2. SSP Stainless Steel Pipe

3. CIP Cast Iron Pipe

4. DIP Ductile Cast Iron Pipe

5. Copper

6. Alu. Aluminum pipe

7. ACP Asbestos Cement Pipe

8. FPG Fiberglass Pipe

9. Other It is possible to enter other materials, which are not included in previous eight items. Once item 9 is selected, the relevant pipe sound velocity must be entered.

M10	Pipe settings	*R
Size	M.	
OD	108.0	mm
thk	4.0	mm

M10	Pipe settings	*R
Size	M.	
M.	0.PVC	
Other	3200	m/s

M11

Lining

Enter liner thickness.

Refer to item 9 "Other"; it is possible to enter other materials, which are not included in previous eight items. Once item 9 is selected, the relevant pipe sound velocity must be entered.

Use and to switch.

M11	Lining	*R
Size	M.	
thk	3.0	mm

Manual Flödesmätare Ultraljud LRF-3000S (Energi)

www.processcenter.se

M11
Lining
Enter liner thickness.

M11	Lining	*R
Size	M.	
M.	0.No Liner	
Other	2400	m/s

Select the Liner Material.
The following options are available:

0. No liner
1. Tar Epoxy
2. Rubber
3. Mortar
4. PP Polypropylene
5. Polystyrol
6. PS Polystyrene
7. Polyester
8. PE Polyethylene
9. Ebonite
10. Teflon
11. Other

Item 11 "Other" is available to enter other materials that are not included in previous ten items. Once the "Other" is selected, the relevant liner sound velocity must be entered.

M12

Medium

Select the temperature of water.
Temperature should be 0-80 deg. C.
Press "Enter" to confirm.
Note: Room temperature is 25 deg.C

M12	Medium	*R
WTMP	20	(° C)

Manual Flödesmätare Ultraljud LRF-3000S (Energi)

www.processcenter.se

M13

Transducer

Select transducer type

The following options are available:

0. Clamp-On C
1. Clamp-On D
2. Clamp-On X
3. Plus-In
4. Plus-In X

Select transducer Mounting Methods

Three mounting methods are available:

0. V Reflect method
1. Z Direct method
2. N

M13	Ttransducer	*R
Type	Method	Mode
Option	0.Clamp-On C	

M13	Ttransducer	*R
Type	Method	Mode
Option	0.Clamp-On C	

M13	Ttransducer	*R
Type	Method	Mode
Option	0.V	

M14

Installation space

This value is calculated by the flow meter

The operator must mount the transducer according to the transducer spacing displayed (ensure that the transducer spacing is measured precisely during installation). The system will display the data automatically after the pipe parameter had been entered.

M14	INSTL Spacing	*R
Value	20.0	mm

Manual Flödesmätare Ultraljud LRF-3000S (Energi)

www.processcenter.se

M20

Damping

The damping factor ranges from 1 ~ 999 seconds. 1 indicates no damping; 999 indicates the maximum damping.

The damping function will stabilize the flow display.

Usually a damping factor of 3 to 10 is recommended in applications.

M20	Damping	*R
Value	6	

M21

Low Vel. Cut off

Low Flow Cut off is used to make the system display as "0" value at lower and smaller flows to avoid any invalid totalizing. For example, if the cutoff value is set as 0.03, system will take all the measured flow velocity values from - 0.03 to + 0.03 as "0". Generally, 0.03 is recommended in most applications.

M21	Low Vel. Cutoff	*R
Value	0.03	m/s

M22

Zero Settings

When fluid is in the static state, the displayed value is called "Zero Point". When "Zero Point" is not at zero in the flow meter, the difference is going to be added into the actual flow values and measurement differences will occur in the flow meter.

Set zero must be carried out after the transducers are installed and the flow inside the pipe is in the absolute static state (no liquid movement in the pipe). Thus, the "Zero Point" resulting from different pipe mounting locations and parameters can be eliminated. The measuring accuracy at low flow is enhanced by doing this and flow offset is eliminated.

Select "YES"; reset "Zero Point" which was set by the user.

M22	Zero Settings	*R
Cutoff	Reset	Offset
Option	0.No	

M22	Zero Settings	*R
Cutoff	Reset	Offset
Option	0.No	

Manual Flödesmätare Ultraljud LRF-3000S (Energi)

www.processcenter.se

This method is not commonly used. It is only suitable for experienced operators to set zero under conditions when it is not preferable to use other methods. Enter the value manually to add to the measured value to obtain the actual value. For example:

Actual measured value = 240 m³/H

Value Deviation = 10 m³/H

Flow meter Display = 250 m³/H

Normally, set the value as "0".

Use "▲" and "▼" to switch.

M22	Zero Settings	*R
Cutoff	Reset	Offset
Value	0.0	m ³ /h

M23

Totalizer

Select the totalizer type

- 0. POS Positive Totalizer
- 1. NEG Negative Totalizer
- 2. NET

Select energy type

- 0. Heat
- 1. Cool

Select "ON"/"OFF" to switch the totalizer.

Select the flow totalizer value you want Reset

- 0. POS Positive Totalizer
- 1. NEG
- 2. NET Negative Totalizer
- 3. All

Select the energy totalizer value you want Reset

- 0. Heat
- 1. Cool
- 2. All

M23	Totalizer	*R
Switch	Reset	
Flow	0.POS	0.ON
Energy	0.Heat	0.ON

M23	Totalizer	*R
Switch	Reset	
Flow	0.POS	
Energy	0.Heat	

Manual Flödesmätare Ultraljud LRF-3000S (Energi)

www.processcenter.se

M24

Temperature

Select Heat Input Options:

- 0. RTD
- 1. AI

Use “” and “” to switch

Temperature Sensitivity Setting

When the delta temperature is less than the sensitivity set, energy will not be accumulated. Set the adjustable temperature range of 0°C ~ 20°C. The factory default setting is 0.2 .

Select Specific Heat Options:

- 0. CJ128 SHC
- 1. Other

Use “” and “” to switch.

M24	Temperature	*R
Source	SSTV	SHC
Option	0.RTD	

M24	Temperature	*R
Source	SSTV	SHC
Value	0.20	° C

M24	Temperature	*R
Source	SSTV	SHC
Option	0.CJ128	m ³ /h
Other	4.2	KJ/m ³ · C

M25

Power Down Correction Switch

With the function of power down automation correction switch, the flow lost in an offline session can be estimated and automatically adjusted. The estimate is based on the average value, which is obtained from flow rate before going offline and flow measured after going online the next time, multiplied times the time period that the meter was offline. Select "ON" to use this function, select "OFF" to cancel this function.

M25	PowerDown COMP	*R
Option	0.ON	

Manual Flödesmätare Ultraljud LRF-3000S (Energi)

www.processcenter.se

M28

SQA

Statistic Analysis

M28	SQA	*R
Set	Reset	
Option	0.ON/1.OFF	
Value	4.500	

M28	SQA	*R
Set	Reset	
Option	0.Auto	
Value	4.500	

M30

RS232/RS485

Serial Port Setting

. 2400 None

. 4800 None

. 9600 None

. 19200 None

. 38400 None

. 56000 None

M30	RS232/RS485	*R
Option	0.2400 None	
ID	55	

M31

AI Setting

Display analog input AI1 analog value.

M31	AI Settings	*R
AI1	AI2	
LowerL	1.0	
UpperL	1000.0	

Manual Flödesmätare Ultraljud LRF-3000S (Energi)

www.processcenter.se

M26

K Factor

The K factor is used to modify the measurement results. The user can enter a numerical value (other than "1") according to the actual calibration results.

M26	K Factor	*R
Value	1.000	

M27

Correction

K-Array

Sectional Correction

ON: Open the Sectional Correction Function;

OFF: Close the Sectional Correction Function

M27	Correction	*R
KArray	Delay	TPC
Option	0.ON	
Value	*****	

Delay correction

Engineer menu, suggest customer use the factory setting.

M27	Correction	*R
KArray	Delay	TPC
Value	0.0	us

TPC

Transducers power control

Engineer menu, suggest customer use the factory setting.

- 0. Auto
- 1. Low
- 2. High

M27	Correction	*R
KArray	Delay	TPC
Option	0.Auto	

Manual Flödesmätare Ultraljud LRF-3000S (Energi)

www.processcenter.se

M33

OCT Setting

The following signal options are available:

- a. Flow Rate
- b. POS Total
- c. NEG Total
- d. NET Total
- e. Energy Rate
- f. Heat Total
- g. Cool Total
- h. Rationing
- i. Uart CTRL

Select the OCT Range value.

M33	OCT Settings	*R
Mode	Range	Check
Option	a.Flow Rate	
Frang	0-5000 Hz	

M33	OCT Settings	*R
Mode	Range	Check
LowerL	0.0	m ³ /h
UpperL	1000.0	m ³ /h

OCT check opinions

- a. Check 500
- b. Check 1000
- c. Check 3000
- d. Check 5000

M33	OCT Settings	*R
Mode	Range	Check
Option	a.Check 500	

Manual Flödesmätare Ultraljud LRF-3000S (Energi)

www.processcenter.se

Display analog input AI2 analog value.

M31	AI Settings	*R
AI1	AI2	
LowerL	1.0	
UpperL	1000.0	

M32

CL Setting

Current Loop Mode Options

Select the CL Range value

Set the CL output value according to the flow value at 4mA or 0mA.

Set the CL output value according to the flow value at 20mA.

4-20mA check opinions

- Check 4mA
- Check 8mA
- Check 12mA
- Check 20mA

M32	CL Settings	*R
Mode	Range	Check
Option	a.4-20mA	

M32	CL Settings	*R
Mode	Range	Check
LowerL	0.0	m ³ /h
UpperL	1000.0	m ³ /h

M32	CL Settings	*R
Mode	Range	Check
Option	a.Check 4mA	

Manual Flödesmätare Ultraljud LRF-3000S (Energi)

www.processcenter.se

M34

Relay Setting

The following signal options are available:

- a. No Signal
- b. *E
- c. Reverse
- d. Alarm1
- e. Alarm2
- f. Ration
- g. POS Total
- h. NEG Total
- i. NET Total
- j. Not Using

M34	Relay Settings	*R
Option	a.No Signal	

M35

Alarm Setting

Enter the Lower \ alarm value, any of the measured flow, which is lower than the low value, will activate the alarm in the OCT hardware or relay output signal.

M35	Alarm Settings	*R
Alarm1	Alarm2	
LowerL	0.0	m ³ /h
UpperL	1000.0	m ³ /h

Enter the Upper alarm value, any of the measured flow, which is higher than the high value, will activate the alarm in the OCT hardware or relay output signal.

M35	Alarm Settings	*R
Alarm1	Alarm2	
LowerL	0.0	m ³ /h
UpperL	1000.0	m ³ /h

Manual Flödesmätare Ultraljud LRF-3000S (Energi)

www.processcenter.se

M36

Ration

Following is the Ration opinions:

- a. Key CTRL
- b. AI1 CTRL
- c. AI2 CTRL
- d. Uart CTRL

M36	Ration	*R
Option	a.Key CTRL	
Value	1000.0	m ³ /h

M37

Micro SD

Following is the opinions for the record.

- a. No Energy
- b. All

Input the data collection time interval in this menu.
Time is in seconds. The interval can be selected in the range of 1 ~ 3600 seconds.

NOTE: this is an option.

M37	Micro SD	*R
Option	a.No Energy	
Cycle	60s	

M40

Toggle Unit

Select the measurement unit as follows:

- a. Metric
- b. British

M40	Toggle Unit	*R
Option	a.Metric	

M41

Flow Unit

The following flow rate units are available:

0. Cubic Meters (m³)
1. Liters (l)
2. USA Gallons (GAL)

M41	Flow Unit	*R
Unit	MULT.	
Rate	m ³ /h	
Total	m ³	

Manual Flödesmätare Ultraljud LRF-3000S (Energi)

www.processcenter.se

M43

Temperature Unit

- a. °C
- b. °F

Use “” and “” to switch.

M43	TEMP Unit	*R
Option	a. °C	

M50

Serial Number

Display electronic serial number (S/N) of the instrument. This S/N is the only one assigned to each flow meter ready to leave the factory. The factory uses it for files setup and for management by the user.

SVN is the software version

M50	Serial Number	*R
S/N	FT888888	
SVN	V1.07	

M51

Time and Data

Date and time modifications are made in this menu.

M51	Time/Data	*R
Tme	8:10:20	
Date	2017/8/16	

M52

Key Tone

Use this menu to “ON”/ “OFF” the key tone.

M52	Key Ton	*R
Option	0.ON	

Manual Flödesmätare Ultraljud LRF-3000S (Energi)

www.processcenter.se

3. Imperial Gallons (Imp gal)
4. Million Gallons (mg)
5. Cubic Feet (cf)
6. USA Barrels (US bbl)
7. Imperial Barrels (Imp bbl)
8. Oil Barrels (Oil bbl)

The following time units are available:

/Day /Hour
/Min /Sec

Factory default is Cubic Meters/hour.

a. x 0.001 (E-3)	b. x 0.01(E-2)
c. x 0.1(E-1)	d. x 1(E+0)
e. x 10(E+1)	f. x 100(E+2)
g. x 1000(E+3)	h. x 10000(E+4)

M41	Flow Unit	*R
Unit	MULT.	
Option	d. *1	

M42

Energy Unit

The following Energy units are available:

0. Giga Joule (GJ)	1. Kilocalorie (Kc)
2. MBtu	3. KJ
4. Btu	5. KWh
6. MWh	7. TH

M42	Energy Unit	*R
Unit	MULT.	
Rate	GJ/h	
Total	GJ	

a. x 0.001 (E-3)	b. x 0.01(E-2)
c. x 0.1(E-1)	d. x 1(E+0)
e. x 10(E+1)	f. x 100(E+2)
g.x 1000(E+3)	h.x 10000(E+4)

M42	Energy Unit	*R
Unit	MULT.	
Option	d. *1	

Manual Flödesmätare Ultraljud LRF-3000S (Energi)

www.processcenter.se

M53

Language

Setting the language of the flow meter

0.English

1.Chinese

M53	Language	*R
Option	0.English	

M54

System Lock

Lock the instrument. Once the system is locked, any modification to the system is prohibited, but the parameter is readable. Entering your designated password correctly can be the only way to "Unlock". The password is composed of 6 numbers. (Please contact the representative or manufacturer as soon as possible when the password is lost.)

M54	System Lock	*R
Option	a.Locked	
Key	*****	

M55

System Reset

Select 1. Reset to make the instrument back to factory.

M55	System Reset	*R
Option	0. None	

M60

Date Totalizer

The following options are available:

- 0. Day
- 1. Month
- 2. Year

In this window, it is possible to review the historical flow data net totalizer for any day for the last 31 days, any month for last 12 months and any year for last 6 years.

M60	Date Totalizer	*R
Day	Mon	Year
Value	08-01	E+0
	100.0	m3

Manual Flödesmätare Ultraljud LRF-3000S (Energi)

www.processcenter.se

M61

Running Time

With this function, it is possible to view the total Working days since the flow meter left the factory.

M61	Running Time	*R
Value	5	Day

M62

CLAdjust

This menu is for the 4-20mA calibration; enter the pass word to adjust.

M62	CL Adjust	*R
4mA	Enter to go	
20mA	Enter to go	

M63

RTD Adjust

This menu is for the RTD calibration; enter the pass word to adjust.

M63	RTD Adjust	*R
0 ° C	Enter to go	
180° C	Enter to go	



Warning

The entire Menu which related to the temperature, cooling, heating, energy. Only display when it's an energy meter. Flow meter doesn't have the function.

Manual Flödesmätare Ultraljud LRF-3000S (Energi)

www.processcenter.se

M64

RTD Adjust

This menu is for the AI calibration; enter the pass word to adjust.

M64	AI adjust	*R
AI1	AI2	
4mA	Enter to go	
20mA	Enter to go	

M64	AI adjust	*R
AI1	AI2	
4mA	Enter to go	
20mA	Enter to go	

7. Error Diagnoses

The ultrasonic flow meter has advanced self-diagnostics functions and displays any errors in the upper right corner of the LCD via definite codes in a date/time order. Some errors can be detected during normal operation. Undetectable errors caused by unskilled operation, incorrect settings and unsuitable measurement conditions can be displayed accordingly during work. This function helps the user detect the errors and find causes quickly; thus, problems can be solved in a timely manner according to the solutions listed in the following table.

If a problem still exists, please contact the factory or the factory's local representative for assistance.

7.1. Table 1. Error Codes and Solutions (during operation)

Codes	The upper right corner of the screen	Causes	Solutions
*R	System Normal	* System normal.	
*E	Signal Not Detected	<ul style="list-style-type: none"> * Signal not detected. * Spacing is not correct between the transducers or not enough coupling compound applied to face of transducers. * Transducers installed improperly. * Scale is too thick. * New pipe liner. 	<ul style="list-style-type: none"> * Attach transducer to the pipe and tighten it securely. Apply a plenty of coupling compound on transducer and pipe wall. * Remove any rust, scale, or loose paint from the pipe surface. Clean it with a file. * Check the initial parameter settings. * Remove the scale or change the scaled pipe section. Normally, it is possible to change a measurement location. The instrument may run properly at a new site with less scale. * Wait until liners solidified and saturated.
*D	Adjusting Gain	* Adjusting gain for normal measurement.	

7.2. Frequently Asked Questions and Answers

Question: New pipe, high quality material, and all installation requirements met: why still no signal detected?

Answer: Check pipe parameter settings, installation method and wiring connections. Confirm if the coupling compound is applied adequately, the pipe is full of liquid, transducer spacing agrees with the screen readings and the transducers are installed in the right direction.

Question: Old pipe with heavy scale inside, no signal or poor signal detected: how can it be resolved?

Answer: Check if the pipe is full of fluid. Try the Z method for transducer installation (If the pipe is too close to a wall, or it is necessary to install the transducers on a vertical or inclined pipe with flow upwards instead of on a horizontal pipe).

Carefully select a good pipe section and fully clean it, apply a wide band of coupling compound on each transducer face (bottom) and install the transducer properly.

Slowly and slightly move each transducer with respect to each other around the installation point until the maximum signal is detected. Be careful that the new installation location is free of scale inside the pipe and that the pipe is concentric (not distorted) so that the sound waves do not bounce outside of the proposed area.

For pipe with thick scale inside or outside, try to clean the scale off, if it is accessible from the inside. (Note: Sometimes this method might not work and sound wave transmission is not possible because of the a layer of scale between the transducers and pipe inside wall).

Question: Why is the CL output abnormal?

Answer: Check to see if the desired current output mode is set in Window M32-Mode.

Check to see if the maximum and minimum current values are set properly in Windows M32-Range.

Re-calibrate CL and verify it in Window M32-Check.

Question: Why is the flow rate still displayed as zero while there is fluid obviously inside the pipe and a symbol of "R" displayed on the screen?

Answer: Check to see if "Set Zero" was carried out with fluid flowing inside the pipe (Refer to Window M22).

If it is confirmed, recover the factory default in Window M22-Reset.

8. Appendix3 – Serial Interface Network Use and Communications Protocol

8.1. Overview

The flow meter has perfect communication protocol. It can also be connected to a RS-485 Modbus .

Two basic schemes can be chosen for networking, i.e. the analog current output method only using the flow meter or the RS232 communication method via serial port directly from the flow meter. This method is suitable to replace dated instruments in old monitoring networks. The later method is used in new monitoring network systems. It has advantages include low hardware investment and reliable system operation.

When the serial port communications method is directly used to implement a monitoring network system, the address identification code of the flow meter is used as a network address code. Expanded command set with [W] is used as communication protocol.

RS-232 (Cable length 0 ~ 15m) or RS-485 (cable length 0 ~ 1000m) can be directly used for data transmission links for a short distance. Current loop can be used in medium or long distance transmission.

When the flow meter is used in a network environment, various operations can be performed by a host device, except for programming of the address identification code, which needs to be done via the flow meter keyboard.

The command answer mode is used in data transmission, i.e. the host device issues commands and the flow meter answers correspondingly.

Common/special flow / thermal data monitoring system developed by our company can be used for flow data collection. Based on characteristics of the flow meter, the system makes full use of software and hardware designs with flow meter features. The system is simple, clear, economical, and reliable in operation.



Attention

In the communication protocol used functions, RS232 and RS485 serial communications cannot be used at the same time.

8.2. Serial port definitions

Flow meter - RS232:	PIN 3 TXD send
TXD send	PIN 4 ground
RXD receive	PIN 5 ground
GND ground	PIN 6 empty
PC:	PIN 7 empty
PIN 1 empty	PIN 8 empty
PIN 2 RXD send	PIN9empty

Manual Flödesmätare Ultraljud LRF-3000S (Energi)

www.processcenter.se

7.1. Direct connection via RS232 to the host device

See the below list of flowmeter serial port definitions.

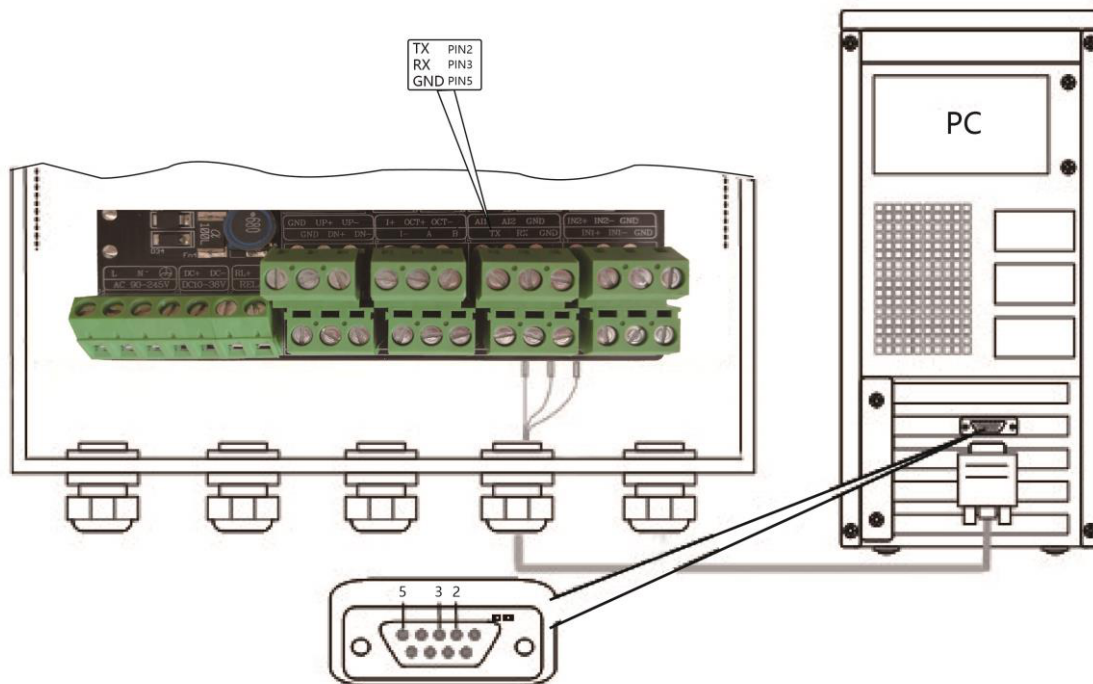

7.2. Communications protocol and the use

The flow meter supports these three communication protocols: FUJI Protocol, MODBUS-C Protocol, MODBUS-I Protocol.

7.2.1. HL Protocol

The communication protocol format used by the ultrasonic flow meter is an expanded set of the HL FLV series flow meter protocol. The host device requests the flow meter to answer by sending a "command". The baud rate of asynchronous communication (Primary station: computer system; Secondary station: ultrasonic flow meter) is generally 9600BPS. A single byte data format (10 bits): one start bit, one stop bit and 8 data bits. Check bit: none.

A data character string is used to express basic commands and a carriage return (ENTER) is used to express the end of a command. The characteristic is that the string of data is flexible. The order applies to both RS232 and RS485. Frequently used commands are as follows:

Communications commands

Manual Flödesmätare Ultraljud LRF-3000S (Energi)

www.processcenter.se

RT-(cr)(lf)	Return negative accumulative flow	±ddddddd.d±d(cr)
RTN-(cr)(lf)	Return net accumulative flow	±ddddddd.d±d(cr)
RTH-(cr)(lf)	Return net accumulative energy(hot)	±ddddddd.d±d(cr)
RT-(cr)(lf)	Return net accumulative energy(cold)	±ddddddd.d±d(cr)
RER-(cr)(lf)	Return instantaneous energy value	±d.dddddE±dd(cr)
RA1-(cr)(lf)	Return analog input value of AI1 (Temperature, Pressure, etc.)	±d.dddddE±dd(cr)
RA2-(cr)(lf)	Return analog input value of AI2 (Temperature, Pressure, etc.)	±d.dddddE±dd(cr)
RID-(cr)(lf)	Return Net address of the instrument	dddd(cr) 5 bits in length
RSS-(cr)(lf)	Return signal intensity	UP:dd.d, DN:dd.d, Q=dd(cr)
REC-(cr)(lf)	Return current error code	*R/*D/*E Note 3
RRS-(cr)(lf)	Return Relay Status	ON/OFF(cr)
RDT-(cr)(lf)	Current date and time	yy-mm-dd, hh:mm:ss(cr)
RSN-(cr)(lf)	Return serial number	ddddddt(cr) Note 4
SFQddd.d(cr)(lf)	OCT setting	ddd.d(cr) Successful setting will back to "OK"
SCLdd.d(cr)(lf)	Current setting	dd.d(cr) Successful setting will back to "OK"
SRS-(cr)(lf)	Start quantitative control	OK(cr) Successful setting will back to "OK"
P	Prefix of return command with check	Note 5
W	Networking command prefix of numeric string address	Note 6

Note:

- 1.(cr)expresses carriage return. Its ASCII value is 0DH. (lf) expresses line feed. Its ASCII value is 0AH.
- 2."d" expresses 0-9 number. 0 value is expressed as +0.000000E+00.
- 3."d" expresses 0-9 numbers. There is no decimal point in integral part before "E".
4. dddddddd means the serial number of the instrument, t means the model of the instrument.
5. The character P can be added before every basic command. It means that the transferred data has CRC verification. The method of verification is to add all of the data back to the data, which is cumulative and binary, and its low 8-bit binary data is taken.

Manual Flödesmätare Ultraljud LRF-3000S (Energi)

www.processcenter.se

E.g. The return information of the RT(cr)(lf) is :+1234567E+0m3(cr)(lf), (the relative binary system data is 2BH, 31H, 32H, 33H, 34H, 35H, 36H, 37H, 45H, 2BH, 30H, 6DH, 33H, 20H, 0DH, 0AH) The sum of all of its return data is =2BH+31H+32H+33H+34H+35H+36H+37H+45H+2BH+30H+6DH+33H+20H=2F7, The low 8-bit data of its binary is F7.

Therefore, the data of the order PRT (cr) (lf) is called + 1234567E + 0m3!F7 (cr) (lf), "!"For delimiters, the preceding is the character of the summation, followed by a check code of 1 byte.

6.Usage of prefix W: W+ numeric string address code +basic command. Value range of the numeric string is 0 ~ 255, except 13 (0DH carriage return), 10 (0AH line feed). If the instantaneous velocity of No. 123 flow meter is to be accessed, the command W123DV (cr)(lf) can be issued. The corresponding binary code is 57H, 31H, 32H, 33H, 44H, 56H, 0DH, 0AH, only the same instrument with the same address of the Internet address and command will send back the data.

7.W and P commands can be used in combination, for example, W123PRT +, which means that the instrument that reads the network address is the cumulative value of the instrument with 123, and its return data has eight accumulations and checksums."s" expresses ON or OFF or UD. For example, "TR:ON, RL:ON" expresses that the OCT and relay are in an actuated status; "TR:UD, RL:UD" expresses that the OCT and relay are not actuated.

8.4.2. MODBUS-I Communication Protocol

This MODBUS-I Protocol uses RTU transmission mode. The Verification Code uses CRC-16-IBM (polynomial is $X^{16}+X^{15}+X^2+1$, shield character is 0xA001) which is gained by the cyclic redundancy algorithm method.

MODBUS-I RTU mode uses hexadecimals to transmit data.

1. MODBUS-I Protocol Function Code and Format

The flow meter protocol supports the following two-function codes of the MODBUS:

Function Code	Performance data
0x03	Read register
0x06	Write single register

2. MODBUS Protocol function code 0x03 usage

The host sends out the read register information frame format:

Slave Address	Operation Function Code	First Address Register	Register Number	Verify Code
1 byte	1 byte	2 bytes	2 bytes	2 bytes
0x01 ~ 0xF7	0x03	0x0000 ~ 0xFFFF	0x0000 ~ 0x7D	CRC (Verify)

The slave returns the data frame format:

Slave Address	Read Operation Function Code	Number of Data Bytes	Data Bytes	Verify Code
1 byte	1 byte	1 byte	N*x2 byte	2 bytes

Manual Flödesmätare Ultraljud LRF-3000S (Energi)

www.processcenter.se

0x01 ~ 0xF7	0x03	2xN*	N*x2 (Data)	CRC (Verify)
-------------	------	------	---------------	----------------

N* = Data register number

3. MODBUS Protocol function code 0x06 usage

The host sends a command to write a single register information frame format (function code 0x06):

Slave Address	Operation Function Code	Register Address	Register Data	Verify Code
1 byte	1 byte	2 bytes	2 bytes	2 bytes
0x01 ~ 0xF7	0x06	0x0000 ~ 0xFFFF	0x0000 ~ 0xFFFF	CRC (Verify)

The slave returns the data frame format (function code 0x06):

Slave Address	Operation Function Code	Register Address	Register Data	Verify Code
1 byte	1 byte	2 bytes	2 bytes	2 bytes
0x01 ~ 0xF7	0x06	0x0000 ~ 0xFFFF	0x0000 ~ 0xFFFF	CRC (Verify)

The range of flow meter addresses 1 to 247 (Hexadecimal: 0x01 ~ 0xF7), and can be checked in the Menu 46. For example, decimal number "11" displayed on Menu 46 means the address of the flow meter in the MODBUS protocol is 0x0B.

The CRC Verify Code adopts CRC-16-IBM (polynomial is $X^{16}+X^{15}+X^2+1$, shield character is 0xA001) which is gained by the cyclic redundancy algorithm method. Low byte of the verify code is at the beginning while the high byte is at the end.

For example, to read the address 1 (0x01) in the RTU mode, if the instantaneous flow rate uses hour as a unit (m³/h) , namely reads 40005 and 40006 registers data, the read command is as follows:

0x01 0x03 0x00 0x04 0x00 0x02 0x85 0xCA

Flow meter Address Function Code First Address Register Register Numbers CRC Verify Code

Flow meter returned data is (assuming the current flow=1.234567m³/h)

0x01 0x03 0x04 0x06 0x51 0x3F 0x9E 0x3B 0x32

Flow meter Address Function Code Data Bytes Data (1.2345678) CRC Verify Code

The four bytes 3F 9E 06 51 is in the IEEE754 format single precision floating point form of 1.2345678.

Pay attention to the data storage order of the above example. Using C language to explain the data, pointers can be used directly to input the required data in the corresponding variable address, the low byte will be put at the beginning, such as the above example 1.2345678 m/s, 3F 9E 06 51 data stored in order as 51 06 9E 3F.

For example, it converts the address 1 (0x01) to 2 (0x02) under the RTU mode, so to write the data of flowmeter 44100 register as 0x02, the write command is as follows:

0x01 0x06 0x10 0x03 0x00 0x02 0xFC 0xCB

Flow meter Address Function Code Register Address Register Number CRC Verify Code

Flow meter returned data is:

0x01 0x06 0x10 0x03 0x00 0x02 0xFC 0xCB

Manual Flödesmätare Ultraljud LRF-3000S (Energi)

www.processcenter.se

Flow meter Address Function Code Register Address Register Number CRC Verify Code

4. Error Check

The flow meter only returns one error code 0x02 which means data first address in error.

For example, to read address 1 (0x01) of the flow meter 40002 register data in the RTU mode, the flow meter considers it to be invalid data, and sends the following command:

0x01 0x03 0x00 0x01 0x00 0x01 0xD5 0xCA

Flow meter Address Function Code Register Address Register Number CRC Verify Code

Flow meter returned error code is:

0x01 0x83 0x02 0xC0 0xF1

Flow meter Address Error Code Error Extended Code CRC Verify Code

5. MODBUS Register Address List

The flow meter MODBUS Register has a read register and a write single register.

a) Read Register Address List (use 0x03 function code to read)

PDU Address	Register	Read	Write	Type	No. registers*
\$0000	40001	Flow/s - low word	32 bits real	2	
\$0001	40002	Flow/s - high word			
\$0002	40003	Flow/m - low word	32 bits real	2	
\$0003	40004	Flow/m- high word			
\$0004	40005	Flow/h - low word	32 bits real	2	
\$0005	40006	Flow/h - high word			
\$0006	40007	Velocity – low word	32 bits real	2	
\$0007	40008	Velocity – high word			
\$0008	40009	Positive total – low word	32 bits int.	2	
\$0009	40010	Positive total – high word			
\$000A	40011	Positive total – exponent	16 bits int.	1	
\$000B	40012	Negative total – low word	32 bits int.	2	

Manual Flödesmätare Ultraljud LRF-3000S (Energi)

www.processcenter.se

\$000C	40013	Negative total – high word			
\$000D	40014	Negative total – exponent	16 bits int.	1	
\$000E	40015	Net total – low word	32 bits int.	2	
\$000F	40016	Net total – high word			
\$0010	40017	Net total – exponent	16 bits int.	1	
\$0011	40018	Energy flow – low word	32 bits int.	2	
\$0012	40019	Energy flow – high word			
\$0013	40020	Energy total(hot) –low word	32 bits real	2	
\$0014	40021	Energy total(hot) –high word			
\$0015	40022	Energy total(hot) – exponent	16 bits int.	1	
\$0016	40023	Energy total(cold) –high word	32 bits real	2	
\$0017	40024	Energy total(cold) – exponent			
\$0018	40025	Energy total(cold) – exponent	16 bits int.	1	
\$0019	40026	Up signal int – low word	32 bits real	2	0 ~ 99.9
\$001A	40027	Up signal int – high word			
\$001B	40028	Down signal int – low word	32 bits real	2	0 ~ 99.9
\$001C	40029	Down signal int – high word			
\$001D	40030	Quality	16 bits int.	1	0 ~ 99
\$001E	40031	Error code – char 1	String	1	Refer to "Error Analysis" for detailed codes meanings.
\$003B	40060	Flow velocity unit –char 1,2	String	2	Only m/s right now
\$003C	40061	Flow velocity unit –char 3,4			
\$003D	40062	Flow rate unit –char 1,2	String	2	Note 1

Manual Flödesmätare Ultraljud LRF-3000S (Energi)

www.processcenter.se

\$003E	40063	Flow rate unit –char 3,4			
\$003F	40064	Flow total unit – char 1,2	String	1	
\$0040	40065	Energy rate unit – char1,2	String	2	Note 2
\$0041	40066	Energy rate unit – char 3,4			
\$0042	40067	Energy total unit – char 1,2	String	1	
\$0043	40068	Instrument address –low word	32 bits real	2	
\$0044	40069	Instrument address –high word			
\$0045	40070	Serial number – char 1,2	String	4	
\$0046	40071	Serial number – char 3,4			
\$0047	40072	Serial number – char 5,6	String	4	
\$0048	40073	Serial number – char 7,8			
\$0049	40074	Analog Input AI1 Value- low word	32 bits real	2	Returned temperature value with RTD option
\$004a	40075	Analog Input AI1 Value- high word			
\$004b	40076	Analog Input AI2 Value- low word	32 bits real	2	
\$004c	40077	Analog Input AI2 Value- high word			
\$004d	40078	4-20mA Value- low word	32 bits real	2	Unit: mA
\$004e	40079	4-20mA Value- high word			

b) Single Write Register Address List (use 0x06 performance code to write)

PDU Address	Register	Description	Read/W rite	Type	No. registers*
\$1003	44100	Flow meter address (1 - 255)	R/W	16 bits int.	1
\$1004	44101	Communication Baud Rate 0 = 2400, 1 = 4800, 2 = 9600, 3 = 19200, 4 = 38400, 5 = 56000	R/W	16 bits int.	1

Notes:

Manual Flödesmätare Ultraljud LRF-3000S (Energi)

www.processcenter.se

1. The following flow rate units are available:
 0. "m3" —Cubic Meter
 1. "l" —Liters
 2. "ga" —Gallons
 3. "ig" —Imperial Gallons
 4. "mg" —Million Gallons
 5. "cf" —Cubic Feet
 6. "ba" —US Barrels
 7. "ib" —Imperial Barrels
 8. "ob" —Oil Barrels
2. The following energy units are available:
 0. "GJ" —Giga Joule
 1. "Kc" —Kilocalorie
 2. "MB" —MBtu
 3. "KJ" —Kilojoule
 4. "Bt" —Btu
 5. "Ts" —US Tonnes
 6. "Tn" —US Tons
 7. "kw" —Kwh
3. 16 bits int—short integer, 32 bits int – long integer, 32 bits real—floating point number,
String—alphabetic string

9. Appendix6 - Flow Application Data

9.1. Sound Velocity for Various Materials Commonly Used

Pipe Material	Sound Velocity (m/s)
Steel	3206
ABS	2286
Aluminum	3048
Brass	2270
Cast iron	2460
Bronze	2270
Fiber glass-epoxy	3430
Glass	3276
Polyethylene	1950
PVC	2540

Liner Material	Sound Velocity
Teflon	1225
Titanium	3150
Cement	4190
Bitumen	2540
Porcelain enamel	2540
Glass	5970
Plastic	2280
Polyethylene	1600
PTFE	1450
Rubber	1600

Manual Flödesmätare Ultraljud LRF-3000S (Energi)

www.processcenter.se

9.2. Sound Velocity in Water (1 atm) at different temperatures

t(°C)	v(m/s)	t(°C)	v(m/s)	t(°C)	v(m/s)
0	1402.3	34	1517.7	68	1554.3
1	1407.3	35	1519.7	69	1554.5
2	1412.2	36	1521.7	70	1554.7
3	1416.9	37	1523.5	71	1554.9
4	1421.6	38	1525.3	72	1555.0
5	1426.1	39	1527.1	73	1555.0
6	1430.5	40	1528.8	74	1555.1
7	1434.8	41	1530.4	75	1555.1
8	1439.1	42	1532.0	76	1555.0
9	1443.2	43	1533.5	77	1554.9
10	1447.2	44	1534.9	78	1554.8
11	1451.1	45	1536.3	79	1554.6
12	1454.9	46	1537.7	80	1554.4
13	1458.7	47	1538.9	81	1554.2
14	1462.3	48	1540.2	82	1553.9
15	1465.8	49	1541.3	83	1553.6
16	1469.3	50	1542.5	84	1553.2
17	1472.7	51	1543.5	85	1552.8
18	1476.0	52	1544.6	86	1552.4
19	1479.1	53	1545.5	87	1552.0
20	1482.3	54	1546.4	88	1551.5
21	1485.3	55	1547.3	89	1551.0
22	1488.2	56	1548.1	90	1550.4
23	1491.1	57	1548.9	91	1549.8
24	1493.9	58	1549.6	92	1549.2
25	1496.6	59	1550.3	93	1548.5
26	1499.2	60	1550.9	94	1547.5
27	1501.8	61	1551.5	95	1547.1
28	1504.3	62	1552.0	96	1546.3
29	1506.7	63	1552.5	97	1545.6
30	1509.0	64	1553.0	98	1544.7
31	1511.3	65	1553.4	99	1543.9
32	1513.5	66	1553.7		
33	1515.7	67	1554.0		

Refer to the sound velocity of other fluids and materials, please contact the factory.